



APEX 9000 Digital Positioner Automax Valve Automation Systems



Experience In Motion



APEX 9000 Digital Positioner

Description

The APEX 9000 is a compact digital positioner that is very simple and quick to install and operate. To calibrate it, simply press the button for 5 seconds, the APEX 9000 will auto-calibrate and tune itself in a few seconds.

The APEX 9000 can be fitted with optional 4-20 mA feedback transmitter and limit switches. HART communication is also possible as an option.

For visual indication you can select between flat indicator or a dome indicator.

Features and Benefit

- Self-Calibrating
- Modular
- Flexible
- Rotary Applications
- Intrinsically Safe, Non-Incendive, or Explosion proof FM, CSA, and ATEX
- Additional switch and position feedback options
- VDI/VDE 3845
- HART option
- 4-20mA feedback option
- LCD - Menu Options

Intrinsically safe:

ATEX II 1 G  Ex ia IIC T6

FM Class I, Div. 1, Group A, B, C, D T4

FM AEx ia IIC T4

Non-Incendive

FM Class I, Div. 2, Groups A, B, C, D T4 (NIFW)

FM Class I, Div. 2, IIC T4 (NIFW)

Explosion proof:

ATEX II 2 GD Exd IIB + H₂ T6 (Ta: 65°C) T5 (Ta: 80°C)

FM Class I, Div. 1,  Groups B,C,D T6 (Ta: 65°C) T5 (Ta: 80°C),
Class II, Div 1, Groups E,F,G T6 (Ta: 65°C) T5 (Ta: 80°C), Type 4X

IECEx Ex d IIB + H₂ T6 GB Ta: 60°C, Ex tb IIIC 100°C Db Ta:80°C



APEX 9000



APEX 9200
LCD + Menu

1. LED's for status and calibration
2. Calibration/configuration button
3. Modular feedback options



Press button and APEX 9000 will auto calibrate itself.



Press button and APEX 9200 will auto calibrate itself.



APEX 9000 modular design provides many options.

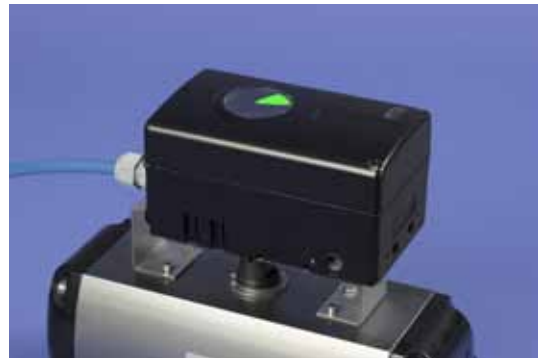

APEX 9000 mounted according to VDI/VDE 3845.



APEX 9000 with LCD, Dome Indicator, and Double Acting module.

APEX 9000 Technical data

APEX 9000/9200 Digital Positioner

Input signal	4-20 mA
Current supply min.	3,6 mA
Current supply Max.	150 mA
Load Standard	400 ohm at 20mA
Load HART	470 ohm at 20mA
User Interface D20	Single push button, LEDs
User Interface D22	LCD menu + 5 push buttons, LEDs
Voltage drop Standard	8 VDC at 20mA
Voltage drop HART	9.4 VDC at 20mA
Angle of rotation min	0-40°
Angle of rotation Max	0-90°
Air supply range	1.5 – 6 bar / 22 – 87 psi
Out put	0-100% of air supply pressure
Air supply quality	Free from oil, dust and moisture IEC 770, ISA 7.0.01
Air supply effect	<0.1%FS for 10% pressure change at 6Bar / 87 psi
Ingress protection	IP66 / Nema 4X
Operating humidity	0-100% rh non-condensing
Air connections	¼" NPT
Gauge ports	1/8" NPT (Bolt on block)
Cable entry	2 x ½" or 2 x M20x 1,5
Terminals	Screw terminals 2,5 mm ² (AWG 14)
Operating Temperature	-20 to +85°C / -4 to +179°F -40°C/F (optional)
Storage temperature	-40 to +85°C / -40 to +179°F
Air delivery capacity	7 Nm ³ /h @ 6 bar / 4.12 SCFM @ 87 psi
Air delivery capacity Double acting	7 Nm ³ /h @ 6 bar / 4.12 SCFM @ 87 psi
Air consumption Single acting	0.120 Nm ³ /h @ 6 bar / 0.071 SCFM @ 87 psi
Air consumption Double acting	0.120 Nm ³ /h @ 6 bar / 0.071 SCFM @ 87 psi
Cv air delivery Single acting	0,12
Cv air delivery Double acting	0,12
Cut off function	Close 0.5% Open 99.5%
Linearity	<1%
Sensitivity	<0.05%
Resolution	<0,1%
Repeatability	<0.2%
Hysteresis + dead band	<0.5%
Temp effect	<0.1%/10K
Mounting position effect	<0,2%
CE	93/68/EEC, 2004/108/EEC, 2006/95/EEC
Housing material	Die cast Aluminium
Surface treatment	Powder coating
Soft goods	Nitrile
Weight	1.4 kg / 3.1 lbs

APEX 9000, 9200 (as above except)

Air delivery capacity	6,3 Nm ³ /h @ 6 bar / 3,7 SCFM @ 87 psi
Cv air delivery:	0.08
Gauge ports	2 x 1/8" NPT
Weight, Al version	3 kg / 6.6 lbs
Weight, Stainless steel version	5.9 kg / 13 lbs

Optional plug in module

Mechanical switches	
Type	SPDT
Size	Sub Sub miniature
Rating	3A, 125 VAC / 2A, 30VDC
Mechanical life	>1 x 10 ⁶ operations
Namur sensors	
Type	P+F NJ2 V3 N Inductive DIN 19234
Load current	<1mA>3mA
Voltage range	5-25 VDC
Hysteresis	3-15% (5% typical)
Temp range	-25° to +100° C (-248° to +373° F)
Namur sensors	
Type	P+F SJ2-N
Normal Voltage	8 VDC
Load current	1mA<l<3mA
Voltage range	5-25 VDC
Hysteresis (max)	0.2%
Temp range	-25° to +100° C (-248° to +373° F)
Namur sensors	
Type	P+F SJ2-SN
Normal Voltage	8 VDC
Load current	1mA<l<3mA
Voltage range	5-25 VDC
Hysteresis (max)	(0.2%)
Temp range	-40° to +100° C (-233° to +373° F)
Namur sensors	
Type	P+F SJ2-S1N
Normal Voltage	8 VDC
Load current	1mA<l<3mA
Voltage range	5-25 VDC
Hysteresis (max)	0.2%
Temp range	-25° to +100° C (-248° to +373° F)
Proximity switches	
Type	SPDT
Rating	10W
Voltage max	200VDC
Current max	500mA
Contact resistance max	0.2 Ohm
Operating time	1.0 ms
Transmitter	
Power supply	12-28 VDC
Output	1-22 mA
Resolution	0.1%
Linearity	±0.5%
Load impedance	600 Ohm at (12 VDC and 20mA)
Alarm Output	
Supply	3-28 VDC
Output	20mA @ 24 VDC

APEX 9000 Digital Positioner Model Code

Brand

AX - Automax

Model

90 - Digital Positioner, Single Button Interface, LED Status

92 - Digital Positioner, Full LCD Menu, LED Status

Approvals, Certifications

G - General Purpose

I - Intrinsically Safe, ATEX/FM

N - Class I Division 2, Non-incendive w/ Fieldwiring, FM

E - Explosion proof ATEX/FM

Connections Air, Electrical

M - 1/4" NPT Air, M20 x 1.5 Electrical

N - 1/4" NPT Air, 1/2" NPT Electrical

Housing/Surface Treatment

U - Aluminum/Powder Epoxy, Black

R - Remote Mount Feedback Sensor

S - Explosion proof, Stainless Steel (N Connectors Only)

Function

S - Single Acting

D - Double Acting

Shaft

23 - NAMUR VDIVDE 3845 Rotary

Cover

1 - Flat Top, No Indicator

2 - Dome Indicator, Red/Green

3 - Flat Top, Disk Indicator, Green/Black

Temperatures/Seals

Z - Standard -20°C to 85°C (-4°F to 185°F)

Q - Low Temperature -40°C to 85°C (-40°F to 185°F)

Input Signal

N - 4-20 mA/None

H - 4-20 mA/HART

Feedback Options

X - No Feedback Options

T - 4-20 mA Transmitter Only

S - Limit Switches, Mechanical SPDT + 4-20 mA Transmitter

N - NAMUR V3 Type Sensor, P&F NJ2-V3-N + 4-20 mA Transmitter

P - Limit Switches, Proximity SPDT + 4-20 mA Transmitter

Options, Add In Electronics

0 - Standard Diagnostics

1 - Advanced, Built in Pressure Sensors (Available in Model 92 Only)

Accessories

X - No Accessories

M - Gauge Block 1/8" G (2 gauges included)

N - Gauge Block 1/8" NPT (2 gauges included)

NOTE 1: If you order double acting, you do not need to order a gauge block. Also comes with 2 gauges, Stainless Steel with brass internals.



Spindles and Dimensions drawings (mm)

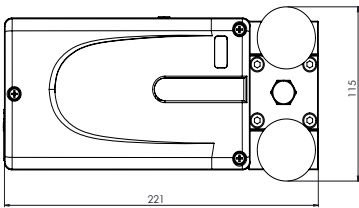

Double acting block

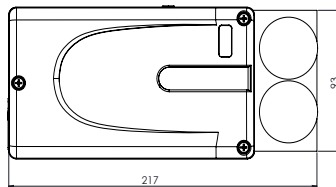

Gauge block

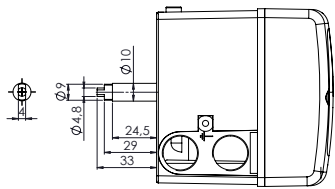

S23 "Namur Spindle"

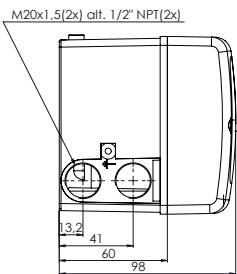

S39 "D Spindle"

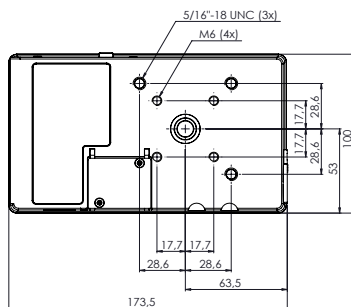

S09 "Double D Spindle"

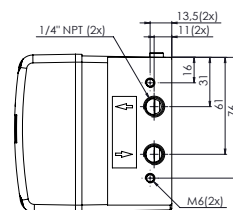

Explosion proof

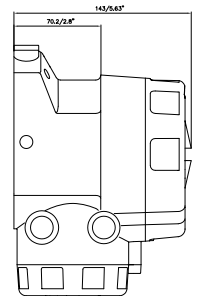
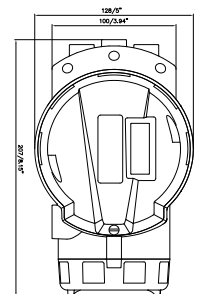
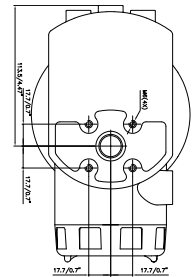



FCD AXENBR0007-01 Printed in USA.

To find your local Flowserve representative:

For more information about Flowserve Corporation, visit www.flowserve.com or call USA 1 800 225 6989

Flowserve Corporation has established industry leadership in the design and manufacture of its products. When properly selected, this Flowserve product is designed to perform its intended function safely during its useful life. However, the purchaser or user of Flowserve products should be aware that Flowserve products might be used in numerous applications under a wide variety of industrial service conditions. Although Flowserve can (and often does) provide general guidelines, it cannot provide specific data and warnings for all possible applications. The purchaser/user must therefore assume the ultimate responsibility for the proper sizing and selection, installation, operation, and maintenance of Flowserve products. The purchaser/user should read and understand the Installation Operation Maintenance (IOM) instructions included with the product, and train its employees and contractors in the safe use of Flowserve products in connection with the specific application.

While the information and specifications contained in this literature are believed to be accurate, they are supplied for informative purposes only and should not be considered certified or as a guarantee of satisfactory results by reliance thereon. Nothing contained herein is to be construed as a warranty or guarantee, express or implied, regarding any matter with respect to this product. Because Flowserve is continually improving and upgrading its product design, the specifications, dimensions and information contained herein are subject to change without notice. Should any question arise concerning these provisions, the purchaser/user should contact Flowserve Corporation at any one of its worldwide operations or offices.

© 2010 Flowserve Corporation, Irving, Texas, USA. Flowserve is a registered trademark of Flowserve Corporation.

Flowserve USA

1978 Foreman Drive
Cookeville, TN 38501
Telephone: +1 931 432 4021
Telefax: +1 931 432 3105

Palmstierna International AB

Korta Gatan 9
SE-171 54 Solna
SWEDEN
Telephone: +46 (0) 8 555 106 00
Telefax: +46 (0) 8 555 106 01

Flowserve Spa

Via Prealpi, 30
20032 Cormano (Milano)
ITALY
Telephone: +39 (0) 2 663 251
Telefax: +39 (0) 2 615 18 63

Flowserve Pte Ltd

No. 12 Tuas Avenue 20
Republic of Singapore 638824
Telephone: +65 (0) 687 98900
Telefax: +65 (0) 686 24940

Flowserve China

Hanwei Building
No. 7 Guanghua Road
Chao Yang District
1000004 Beijing
CHINA
Telephone: +86 (10) 6561 1900
Telefax: +86 (10) 6561 1899