

# VIBRATION TESTING SYSTEMS



## INDEX

4	Product Series
6	Vibration Testing Technology
7	Vibration Testing System Setup
8	VT-MS Series
12	L Series
16	M Series
20	LS Series
24	H Series
28	I Series
32	MET Series
34	MPA Series Power Amplifiers
36	IPA Series Power Amplifiers
38	Slip Table
42	Head Expander
45	Accelerometers
46	Vibration Control
48	Environmental Vibration Test Systems
50	Customized Products & Applications

## YOUR LEADING SUPPLIER OF HIGH RELIABILITY VIBRATION TESTING SYSTEMS

ETS Solutions is formed by an experienced team of engineers with various professional experiences in the vibration and shock testing industry.

With more than five decades of expertise in the business, we've created our own line of efficient instruments and tools to alleviate the need of several industries that include aerospace, defence, automotive, consumer electronics, locomotive, construction and more.

Our talented engineering team works continuously on development of new products and improvement of the existing product range. This has enabled ETS Solutions to deliver products in a shorter time period without compromising quality or cost. We have been successful offering products that exceed the specifications of other vibration equipment manufacturers.

We are passionate about helping our customers produce reliable products by utilizing our equipment and expertise. We strive to consistently deliver quality products, responsive service, and delivering the best value in the industry.

Our superb technical team is constantly improving and innovating our products and this is what motivates us to be a leading innovator and solutions provider in the field of structural testing and measurement with comprehensive and cutting-edge technologies.

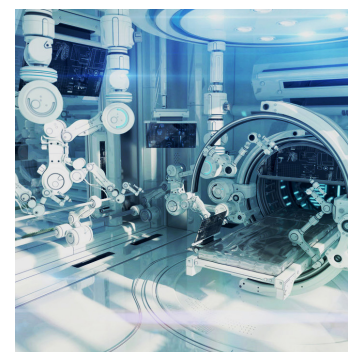
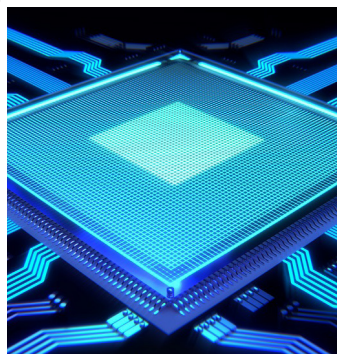

## FEATURES

## APPLICATIONS

### VT SERIES

Solutions to assist engineers to carry out vibration testing on small components and exciting structures for modal and structural analysis

- General mechanical mobility measurements
- Experimental modal analysis on most mechanical structures
- Advanced structural dynamics investigations
- Structural damage detection
- Finite element model correlation
- Ground vibration test
- Modal survey

### MS SERIES

Ideal for production testing of small components, electronic assemblies, sensor calibration and laboratory research

### L SERIES

Ideal for screening of small electronic assemblies, automotive components, handheld units, storage devices, connectors

- Automotive and aerospace component testing
- Electronic assembly testing
- In-house test and calibration facilities
- General mechanical mobility measurements
- Experimental modal analysis on most mechanical structures
- Advanced structural dynamics investigations
- Structural damage detection
- Finite element model correlation
- Ground vibration test
- Modal survey

### M SERIES

Ideal for testing medium to large sized electronic assemblies, automotive parts, and aviation and avionics parts

- Automotive and aerospace parts and modules testing
- Avionics and defence equipment testing
- Satellite module testing
- Consumer electronics devices - quality qualification testing
- Product packaging testing
- Product stress screening

### LS SERIES

Ideal for test applications such as packaging testing and vehicle testing

- Automotive and aerospace parts and modules testing
- Low frequency road simulation test on product and vehicle parts
- Product packaging testing
- Transportation stress screening on product

### H SERIES

High force system with high performance ideal for testing large sized assemblies with high accelerations

- Squeak & Rattle Test
- Automotive part testing that requires high force and long duration
- High acceleration magnitude testing for aerospace, avionics, military devices
- Large size product packaging testing
- Transportation stress screening on large sized equipment
- Structural test on large size satellite launchers

### I SERIES

Screening of medium sized assemblies with extreme high acceleration test level and high frequency range

- Automotive and aerospace engines component test
- Vehicle exhaust test
- Heavy duty connector test
- Avionics parts testing
- Mil-STD testing

### MET SERIES

Multi-Excitation Testing real world vibration simulation and screening tests

- Real life vibration test replication
- Squeak & Rattle Test
- Automotive part testing with actual field data replication
- Mil-STD 810G
- Avionics parts testing
- Transportation stress screening on medium sized devices
- Structural test on medium size shipboard equipment

# BENEFITS

- Simple system operation
- Reasonable priced optimal performance system for major test standards
- Ultra-compact energy efficient amplifiers output signal indication, overload protection, connectivity error indication, constant current or constant voltage output
- Used in conjunction with Sweeping signal generator
- All-encompassing fuse protection designs for high current system components
- Complies with USA, European and international safety and EMC regulations
- Simple initial self-system setup
- Easy maintenance and rapid servicing

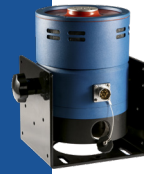

- Complies with USA, European and international safety and EMC regulations
- State-of-the-art microprocessor logic control unit
- Integration with unibase or standalone slip table
- Reasonably priced optimal performance system for major test standards
- Compact shaker and amplifier size saving valuable floor space
- All-encompassing fuse protection designed for high current system components
- Interactive diagnostic 'System Status' displayed on LCD or touch screen
- Compatible with all vibration controllers

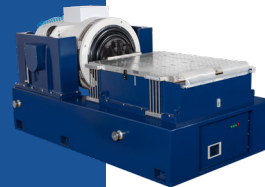

- Complies with USA, European and international safety and EMC regulations
- State-of-the-art microprocessor logic control unit
- Integration with unibase or standalone slip table
- Reasonably priced optimal performance system for major test standards
- Modular multi-cabinet design
- All-encompassing fuse protection designed for high current system components
- Interactive diagnostic 'System Status' displayed on touch screen
- Compatible with all vibration controllers



- Simple system operation; State-of-the-art microprocessor logic control unit
- High-energy conversion efficiency Amplifier (greater than 90%)
- All-encompassing fuse protection designed for high current system components
- Detailed scope of system interlock protection; Complies with USA, European and international safety and EMC regulations
- Compatible with all vibration controllers
- Remote control panel available with full Amplifier features
- Low-profile body design ready for chamber integration
- Integration with unibase or standalone slip table; Simple initial self-system setup



- Complies with USA, European and international safety and EMC regulations
- State-of-the-art microprocessor logic control unit
- Reasonably priced optimal performance system for major test standards
- Modular multi-cabinet design
- All-encompassing fuse protection designed for high current system components
- Interactive diagnostic 'System Status' displayed on touch screen
- Integrated design, compact structure
- Compatible with any multi-axis MDOF vibration controller



# VIBRATION TESTING TECHNOLOGY

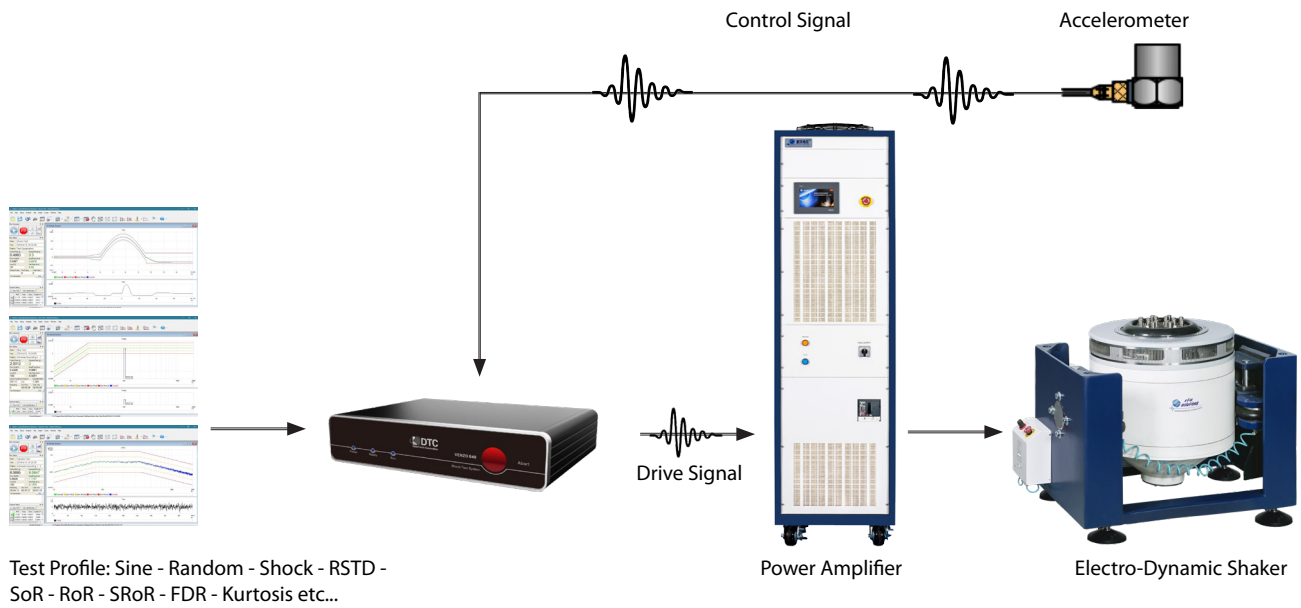

## Basic units used for vibration test

There are four important units for a vibration test:

- Force [N]
- Acceleration [ $m/s^2$ ]
- Velocity [m/s] and
- Displacement [mm peak-to-peak (p-p)]

Calculating Required Force requires application of Newton's Second Law of Motion:

## **F (Force) = M (Mass) x A (Acceleration)**

That is to say, when a mass of 1 kg is accelerated to an acceleration of 1  $m/s^2$  the required force is 1N.

The mass value (M) must include all moving masses attached to the shaker armature surface including the armature mass itself: shaker armature + head expander or slip plate with its driver bar + test specimen + specimen interface fixture, including bolts and bearing friction if the system is driving horizontal plate using hydrostatic bearings.

The maximum acceleration (A) is derived from the customer test specification:

- for Sine Vibration (G-peak)
- for Random Vibration (G-rms)
- for Classical Shock Pulse (G-peak)

The user must know the maximum displacement and velocity of any given test parameters to ensure they choose the right system and they don't exceed the system capabilities.

Suitability of a specific test system can be evaluated in terms of the following:

- Force requirement (lbf or kgf)
- Unit Under Test (UUT) + Fixture Weight + Armature Weight x G = F x 1.30 (30% safety margin)
- The result will give you the required Force for shaker system selection
- Maximum Displacement (determined by test environment)
- Maximum Velocity (determined by test environment)

# VIBRATION TESTING SYSTEM SETUP



The use of vibration in Environmental Stress Screening (ESS) has expanded from the past from purely military applications until today commonly applied in the commercial sector. The use of ESS becomes a standard customer defined requirement in the aerospace and defence related products to ensure safe operation of critical equipment. Commercial product manufacturers today typically have full ESS programs in place with vibration test or combined with thermal cycling. The ESS programs are designed to comply with military and other international standards such as MIL, ASTM, IEC, ISO, BS etc.

The use of vibration in ESS has been proven to be a way to increase product reliability. It is also a tool to assist engineer in the product development process. Simulating the environment condition on the developing product will allow the design engineers to classify and analyse screening data to identify problem areas and recommend early corrective action.

Vibration testing as a part of ESS ensures the occurrence of failures in the product in early stage. These failures then occur before the units leave the manufacturing facility, dramatically improving field reliability. The optimal screening will maintain field failure cost savings.

## PREREQUISITE SYSTEM COMPONENTS

1. Vibration controller required for test profiling control. ETS shakers are compatible with all major vibration controllers.
2. Signal conditioner required to provide current source for accelerometer or function as a charge amplifier.
3. Accelerometer built-in amplifier type or charge-type for signal feedback to vibration controller or data acquisition.

ETS is able to provide a complete system package with a suitable controller of your choice.

## SHAKER ACCESSORIES UNITS

- Optional Remote Control Panel with full logic module replication function at remote site of up to 500m.
- Servo Control Console for static and dynamic and armature auto-centering.
- Customised head expanders and fixtures. Contact us for more information.
- Different sizes of slip table available for horizontal testing. Contact us for more information.

# VT-MS SERIES

Ideal for production testing of small components, electronic assemblies, sensor calibration and laboratory research.

The VT & MS Series applications include modal and structural analysis to measure vibration response of a wide-range of structures in both defence and civil engineering.

VT & MS Series shakers can also be used to test fatigue life and vibration influences on small electric and mechanical components or devices.

In addition, they are often used for the calibration of accelerometers and field vibration measurement systems.



## FEATURES

- Large range of force and displacement output
- Robust flexures providing best cross axial restraint
- Reliable performance
- Rugged, industrial design
- Wide-frequency range, low distortion
- Long-term stable performance
- Small size and lightweight
- Natural convection air cooling, with optional additional forced air cooling (MS)

## PERFORMANCES - BENEFITS

- Simple system operation
- Reasonable priced optimal performance system for major test standards
- Ultra-compact energy efficient amplifiers, output signal indication, overload protection, connectivity error indication, constant current or constant voltage output
- Used in conjunction with sweeping signal generator
- All-encompassing fuse protection designs for high current system components
- Complies with USA, European and international safety and EMC regulations
- Simple initial self-system setup
- Easy maintenance and rapid servicing
- Worldwide spare parts support

Designed using permanent-magnet technology to deliver excitation, this palm-sized unit is suitable for a number of research and educational applications, including structural response testing and vibration transducer and accelerometer calibration. Has light weight, small volume and is convenient to move.

This miniature exciter has a frequency range from 2 - 10 kHz and maximum peak-to-peak displacement of 10 mm. It delivers optimal performance when driven by our 200 VA power amplifier and can impart sine forces up to 50 N.

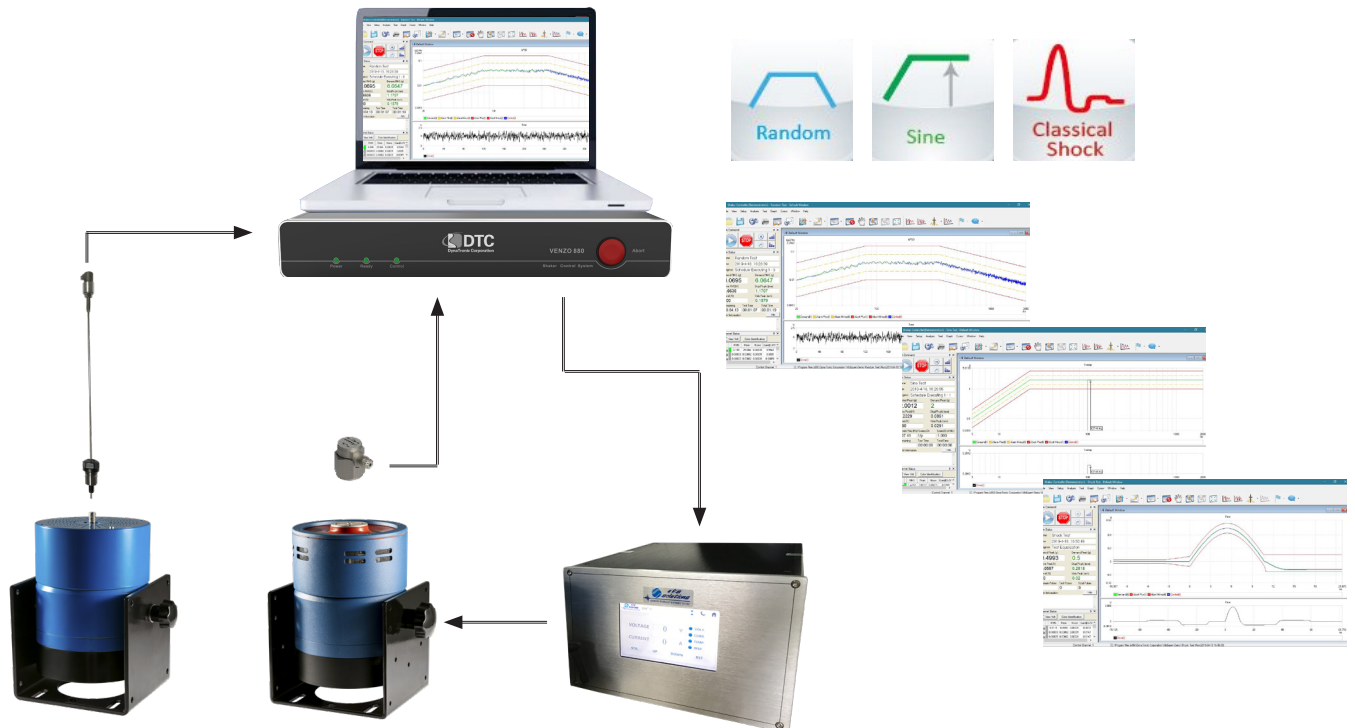

Modal Shaker MS Series Accessories Kit

## Software package include:

- Random - performs real-time closed loop control of PSD profiles
- Sine - performs closed swept sine vibration, to determine resonant frequencies and damping factors, overall peak G response of the structure
- Classical Shock - performs closed loop control of transient waveforms. The entire transient period is sampled simultaneously and gap free. All of the classical types are supported. There are several displacement optimising methods



**SPECIFICATIONS - VT SERIES**

<b>Model</b>	<b>VT50 / ST200 (T)</b>	<b>VT100A / ST450 (T)</b>	<b>VT100B / ST450 (T)</b>	<b>VT200 / ST650 (T)</b>	<b>VT300 / ST750 (T)</b>	<b>VT500 / ST1100 (T)</b>	<b>VT1000 / ST1500 (T)</b>
Rated Peak Force (N) Forced-Air Cooled (Sine/Random)	N/A	100N	N/A	200N	300N	500N/350N	1000N/700N
Rated Peak Force (N) Convention (Sine/Random)	50N	50N	100N	100N	150N	250N/175N	500N/350N
Frequency Range (Hz)	5 - 10,000	5 - 10,000	5 - 7,000	5 - 6,500	5 - 6,500	5 - 5,000	5 - 4,000
Max. Displacement (mm) Peak-Peak	10	10	12	12	12	15	15
Max. Speed (m/s)	1.6	1.6	1.6	1.6	1.6	1.6	1.6
Max. Acceleration Speed (g)	20	35	35	50	65	80	80
Effective Moving Mass (kg)	0.25	0.3	0.4	0.4	0.45	0.63	1.3
Table Diameter (mm)	ø 30	ø 30	ø 50	ø 50	ø 50	ø 50	ø 60
Max. Load (kg)	2	2	3	3	4	4	6
Shaker Weight (kg)	3.6	3.6	14.5	14.5	14.5	15	41
Coupling (Thread ø mm)	4 x M5	4 x M5	4 x M5	4 x M5	4 x M5	4 x M5	4 x M6
Dimensions (W x H x D) (mm)	148 x 95 x 188	148 x 95 x 188	200 x 265 x 250	200 x 265 x 250	200 x 265 x 250	200 x 265 x 250	266 x 347 x 342
Max. Operating Current	4A	8A	5A	10A	10A	10A	13A
DC Resistance (Ω)	1.1	1.1	2.8	2.8	2.8	4	3.8
Protection	Over-displacement Over-current Over-temperature	Over-displacement Over-voltage Over-current Over-temperature	Over-displacement Over-voltage Over-current Over-temperature	Over-displacement Over-voltage Over-current Over-temperature	Over-displacement Over-voltage Over-current Over-temperature	Over-displacement Over-voltage Over-current Over-temperature	Over-displacement Over-voltage Over-current Over-temperature

**SPECIFICATIONS - MS SERIES**

<b>Model</b>	<b>MS50 / ST200 (T)</b>	<b>MS100A / ST450 (T)</b>	<b>MS100B / ST450 (T)</b>	<b>MS200 / ST650 (T)</b>	<b>MS250 / ST650 (T)</b>	<b>MS300 / ST750 (T)</b>	<b>MS500 / ST1100 (T)</b>	<b>MS1000 / ST1500 (T)</b>
Rated Peak Force (N) Forced-Air Cooled (Sine/Random)	N/A	100N	N/A	200N	250N	300N	500N/350N	1000N/700N
Rated Peak Force (N) Convention (Sine/Random)	50N	50N	100N	100N	130N	150N	250N/175N	500N/350N
Frequency Range (Hz)	DC - 10,000	DC - 10,000	DC - 8,000	DC - 8,000	DC - 8,000	DC - 8,000	DC - 6,000	DC - 4,500
Main Resonance Frequency (Hz)	10,000	10,000	5,800	5,800	5,800	5,800	4,700	3,900
Max. Displacement (mm) Peak-Peak	16	16	18	18	18	18	20	20
Max. Acceleration Speed (g)	40	80	35	70	80	100	100	100
Effective Moving Mass (kg)	0.13	0.13	0.32	0.3	0.3	0.3	0.45	1
Shaker Weight (kg)	4	4	14.5	14.5	14.5	15	16	41
Coupling (Thread ø mm)	M6	M6	M6	M6	M6	M6	M6	M6
Dimensions (W x H x D) (mm)	148 x 95 x 188	148 x 95 x 188	200 x 265 x 250	200 x 265 x 250	200 x 265 x 250	200 x 265 x 250	200 x 265 x 250	266 x 347 x 342
Max. Operating Current	4A	8A	5A	10A	10A	10A	10A	13A
DC resistance (Ω)	1.1	1.1	2.8	2.8	2.8	3	4	3.8
Protection	Over-displacement Over-voltage Over-current Over-temperature	Over-displacement Over-voltage Over-current Over-temperature	Over-displacement Over-voltage Over-current Over-temperature	Over-displacement Over-voltage Over-current Over-temperature	Over-displacement Over-voltage Over-current Over-temperature	Over-displacement Over-voltage Over-current Over-temperature	Over-displacement Over-voltage Over-current Over-temperature	Over-displacement Over-voltage Over-current Over-temperature

# VT-MS SERIES POWER AMPLIFIER

SPECIFICATIONS - POWER AMPLIFIER						
Model	ST200 (T)	ST450 (T)	ST650 (T)	ST750 (T)	ST1100 (T)	ST1500 (T)
Linear or Digital Amplifier	linear or digital	linear or digital	linear or digital	linear or digital	linear or digital	linear or digital
Continuous Sine Power Rating	200VA	450VA	650VA	750VA	1100VA	1500VA
Frequency Range (Hz)	DC - 20 kHz	DC - 20 kHz	DC - 20 kHz	DC - 20 kHz	DC - 20 kHz	DC - 20 kHz
Max. Output Voltage	30V	45V	65V	75V	110V	110V
Max. Output Current	6A	10A	10A	10A	10A	13A
Signal Input Voltage	< 3Vrms	< 3Vrms	< 3Vrms	< 3Vrms	< 1Vrms	< 1Vrms
Signal to Noise Ratio	> 90 dB	> 90 dB	> 90 dB	> 90 dB	> 90 dB	> 90 dB
Total Harmonic Distortion	< 1% (1KHZ)	< 1% (1KHZ)	< 1% (1KHZ)	< 1% (1KHZ)	< 1% (1KHZ)	< 1% (1KHZ)
Weight (kg)	4.5	4.5	5	6	6	6.5
Dimensions (W x H x D) (mm)	250 x 160 x 320	250 x 160 x 320	250 x 160 x 320	250 x 160 x 320	480 x 470 x 132	480 x 470 x 132
Adjustment Function	Current & voltage limits	Current & voltage limits	Current & voltage limits	Current & voltage limits	Current & voltage limits	Current & voltage limits
Max. Power Consumption at 230V	440VA	500VA	720VA	820VA	1200VA	1600VA
Protection	Over-voltage Over-current Over-temperature	Over-displacement Over-voltage Over-current Over-temperature	Over-displacement Over-voltage Over-current Over-temperature	Over-displacement Over-voltage Over-current Over-temperature	Over-displacement Over-voltage Over-current Over-temperature	Over-displacement Over-voltage Over-current Over-temperature

Specifications are correct at the time of publication. In keeping with our commitment to continuous product improvement, the information herewith is subject to change. ETS reserves the rights to amend specifications without prior notice.



(T) - Touch Screen

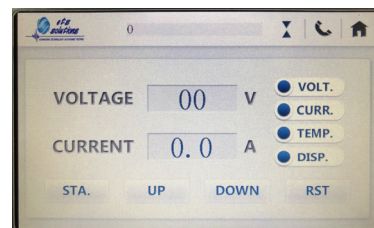

# CALIBRATION SYSTEM

## APPLICABLE OBJECTS

- Working piezoelectric acceleration transducer, velocity transducer and vibrometer while produced, maintained and employed
- Various types of acceleration, velocity transducer and vibrometer, such as voltage type, charge type, IEPE type, TEDS type and so on.

## STANDARD

ISO 16063-21:2003 Vibration and Shock Transducer Calibration Method

## FEATURES

- Calibrate accurately all kinds of acceleration transducer, velocity transducer and vibrometer, including voltage type, charge type, IEPE, TEDS, etc.
- Frequency range is 2Hz-10kHz, support point-by-point comparison calibration, swept sine calibration, random excitation and impact excitation methods, etc.
- High precision and dynamic range, system uncertainty: <1% (160Hz, 100 m/s<sup>2</sup>)
- At the end of calibration, it will automatically generate a detailed report, including sensitivity, linearity and amplitude and frequency response curve; all data will be input database, compiling refers to ISO17025
- Substitution calibration option prolongs the service life of standard transducer
- TEDS transducer support, and results wrote in it
- Power Amplifier with digital display

## CALIBRATION ITEMS

- Sensitivity Calibration: frequency range default 160Hz, acceleration default 10 m/s<sup>2</sup>
- Frequency Response
  - Swept Sine:** Breakpoint tabular form defined the sweep range and reference acceleration value; User defined sweep method (logarithmic or linear), sweep speed and time.
  - Step Sine:** Tabular form defined at least 10 frequency points and its reference acceleration, max. 4096 discrete points, frequency points according to 1/3 octave or 1/1 octave.
  - Random Calibration (FFT):** Breakpoint tabular form defined random profile; User defined RMS value, analysis lines and calibration time.
- Amplitude Linearity: The curve is frequency VS acceleration which reflects the frequency VS sensitivity. Tabular form defined the measurement frequency points.
- Transverse Sensitivity Calibration: The transverse sensitivity is the accelerometer output sensitivity when acceleration is applied at its geometrical right angle.



### Automatic Calibration

Automatically compare sensitivities of the reference and DUT transducers at the operating frequency range. New values saved at end of test.



### Test profile included

Comes with pre-programmed test profile including calibration test report. You can create your own test profiles at any time.



### Custom reporting

Use the report template that comes included or customize your report using Microsoft® Word. VRC offers one of the most flexible custom reporting packages anywhere!



### Writes to TEDS sensors

Upon test completion, new sensitivity values can write to TEDS (Transducer Electronic Data Sheet) embedded within the sensor.

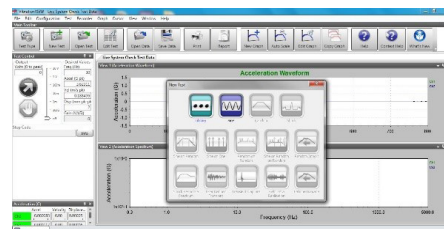

# L SERIES

## Vibration System Force Rating from 200 kgf to 600 kgf

Ideal for screening of small electronics assemblies, automotive components, handheld units, storage devices, connectors.

Designed to meet military and international test standards including MIL, ASTM, IEC, ISO, BS, JIS etc. A large diameter armature with high cross-axial stiffness will allow using a proportioned head expander to test multiple specimens simultaneously yet achieving good vibration transmissibility ratio.

Other test requirements including transportation vibration simulation, combined vibration-climatic test and seismic simulations for small size components can easily be fulfilled by the "L" Series.

ETS Solutions "L" Series is the low-cost vibration product qualification and testing solution for small sized test specimens.



### FEATURES

#### THE PERFORMANCE

- Specimen payload up to 300 kg
- Excellent random performance meeting ISO standard with 3 sigma peak current rating
- Armature diameters range from 150 mm to 200 mm
- Up to 51 mm continuous displacement
- Test frequency up to 4,500 Hz

#### THE SHAKER

- Rugged trunnion design with bearing guidance
- Air bag or elastomer isolator built-in reducing dynamic floor stress
- Dual layer reinforced armature for high acceleration performance
- Roller-truss flexure suspension system with high cross-axial stiffness

#### THE AMPLIFIER

- Integrated with high performance MPA series small sized amplifier
- Modular designed amplifier
- 12 kVA power module with two self-reliant compact 6 kVA sub-modules
- High modulation switching frequency
- High signal to noise ratio
- Low total harmonic distortion
- Individual power module operation indication light

#### THE ACCESSORIES

- Air load support for armature centering
- Dynamic and static armature centering available
- Rotary worm-gear built-in for uni-base slip table
- Thermal barrier for combined climatic chamber test available
- Remote control capabilities available

### BENEFITS

- Simple system operation
- State-of-the-art microprocessor logic control unit
- High-energy conversion efficiency (greater than 90%)
- Reasonable priced optimal performance system for major test standards
- Compact shaker and amplifier size saving valuable floor space
- Shaker air-cooled by rugged outdoor blower for continuous long-period operation
- Air cooled amplifier for safe and reliable operation
- Design to reduced reliance on mechanical switchgears with CPU logic controlled
- All-encompassing fuse protection designed for high current system components
- Detailed scope of system interlock protections
- Complies with USA, European and international safety and EMC regulations
- Compatible with all vibration controllers
- Remote control panel available with full functional features
- Low-profile body design ready for chamber integration
- Integration with unibase or standalone slip table
- Simple initial self-system setup
- Interactive diagnostic "System Status" displayed on LCD
- Easy maintenance and rapid servicing
- Worldwide spare parts support

<b>SPECIFICATIONS - L SERIES</b>			
<b>SYSTEM MODEL</b>	<b>MPA101 / L215M</b>	<b>MPA101 / L315M</b>	<b>MPA102 / L620M</b>
Sine Force	200 kgf	300 kgf	600 kgf
Random Force	200 kgf	300 kgf	600 kgf
Shock Force (½ Sine)	400 kgf	600 kgf	1,200 kgf
Usable Frequency Range	DC to 4,500 Hz	DC to 4,000 Hz	DC to 3,500 Hz
Continuous / Shock Displacement (1)	25.4 mm / 25.4 mm	25.4 mm / 25.4 mm	51 mm / 51 mm
Max. Velocity (Sine)	2.0 m/s	2.0 m/s	2.0 m/s
Max. Acceleration (Sine)	981 m/s <sup>2</sup>	981 m/s <sup>2</sup>	981 m/s <sup>2</sup>
<b>SHAKER UNIT</b>	<b>L215M</b>	<b>L315M</b>	<b>L620M</b>
Armature Diameter	150 mm	150 mm	200 mm
Effective Moving Element Mass	2 kg	2.5 kg	6 kg
Load Attachment Points	12 stainless steel inserts	12 stainless steel inserts	16 stainless steel inserts
Inserts Size (Standard)	M8	M8	M8
Grid Pattern (Diameter, Circle)	6 on Ø 60mm; 6 on Ø 120mm	6 on Ø 60mm; 6 on Ø 120mm	8 on Ø 100mm; 8 on Ø 160mm
Nominal, Bare Table (2)	3,100 Hz	2,900 Hz	3,300 Hz
Max. Static Payload	70 kg	120 kg	300 kg
Natural Frequency (Thrust Axis)	< 5 Hz	< 5 Hz	< 5 Hz
Stray Flux Density (3)	Less than 10 gauss	Less than 10 gauss	Less than 10 gauss
Dimensions (Uncrated) (L x W x H)	696 x 599 x 595 mm	754 x 599 x 620 mm	943 x 633 x 710 mm
Weight (Uncrated)	440 kg	490 kg	730 kg
<b>AMPLIFIER UNIT</b>	<b>MPA101</b>	<b>MPA101</b>	<b>MPA102</b>
Amplifier Output	2 kVA	3 kVA	6 kVA
Total Harmonic Distortion (At Rated Output)	From DC (0.1Hz) to 500Hz less than 0.5%; From 500Hz to 5,000Hz less than 1.0%		
Signal-Noise-Ratio	More than 65 dB at 100 V rms output, 10KΩ input termination with rated resistive load		
DC Stability	Less than 0.05% of full output voltage with 10% change in line voltage		
Input Drive	4 V rms into 10KΩ for full output (120V rms)		
Amplifier Frequency Response (4)	From DC (0.1Hz) to 4,500Hz: ± 3dB; From 10Hz to 3,000Hz: ± 1dB		
Switching Frequency	112 kHz	112 kHz	112 kHz
Max. Output Voltage	120V rms	120V rms	120V rms
Max. Output Current Per Module (Continuous / Transient)	50 A rms / 150 A rms	50 A rms / 150 A rms	50 A rms / 150 A rms
Amplifier Efficiency	> 90%	> 90%	> 90%
Dimensions (Uncrated) (L x W x H)	550 x 680 x 1455 mm	550 x 680 x 1455 mm	550 x 680 x 1455 mm
Weight (Uncrated)	230 kg	230 kg	280 kg
<b>BLOWER UNIT</b>	<b>HP-1A</b>	<b>HP-1A</b>	<b>HP-2A</b>
Power Output	0.75 kW	0.75 kW	4 kW
Air Flow	0.095 m <sup>3</sup> / s	0.104 m <sup>3</sup> / s	0.192 m <sup>3</sup> / s
Air Pressure	0.012 kgf / cm <sup>2</sup>	0.011 kgf / cm <sup>2</sup>	0.06 kgf / cm <sup>2</sup>
Dimensions (Uncrated) (L x W x H)	488 x 373 x 1055 mm	488 x 373 x 1055 mm	748 x 604 x 1450 mm
Weight (Uncrated)	40 kg	40 kg	115 kg

Specifications are correct at the time of publication. In keeping with our commitment to continuous product improvement, the information herewith is subject to change. ETS reserves the rights to amend specifications without prior notice.

**REMARKS:**

1. Test payload should be less than 10% of shaker weight
2. First resonance frequency at ± 5% tolerance
3. Measured at 152mm above armature table. Contact us for lower gauss level requirement.
4. Sine mode, resistive load

# L SERIES

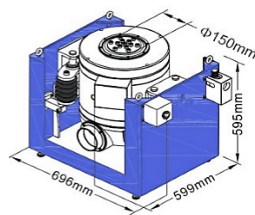
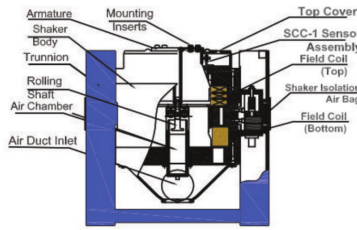

L215M

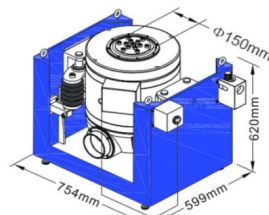

L315M

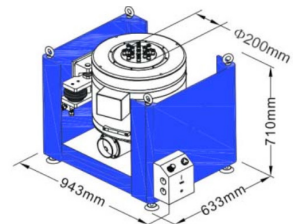

L620M

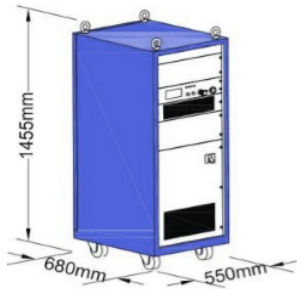

MPA101  
MPA102

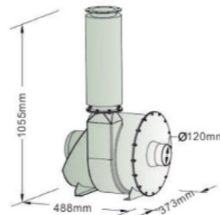

HP-1A

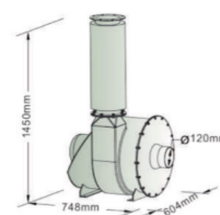

HP-2A

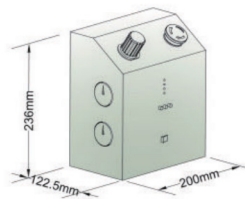

Servo Control Console  
(SCC-1 Unit)



Remote Control Panel  
(RCP)

SYSTEM OPTIONS	MPA101 / L215M	MPA101 / L315M	MPA102 / L620M
Table Inserts			
M8	●	●	●
M10	-	-	○
1/2" UNC	-	-	○
3/8" UNC	○	○	○
Internal Load Support	●	●	●
Thermal Barrier	○	○	○
Unibase Slip Table	○	○	○
Air Caster	○	○	○
Degauss Coil	-	-	-
Electrical Rotation Unit	-	-	-
Air Isolation Trunnion	●	●	●
Geared Aided Rotation (Ratchet Crank)	○	○	○
Servo Control Console (SCC-1 Unit)	-	-	●
Auxiliary Interlock Unit (AIU)	○	○	○
Remote Control Panel (RCP)	○	○	○

● Standard ○ Optional - Not Available

<b>OPERATING ENVIRONMENTAL DATA</b>	<b>MPA101 / L215M</b>	<b>MPA101 / L315M</b>	<b>MPA102 / L620M</b>
Max. Heat Rejection to Air (Shaker)	0.21 kW	0.27 kW	0.54 kW
Max. Heat Rejection to Air (Amplifier)	0.3 kW	0.45 kW	0.85 kW
Max. Heat Rejection to Air (Blower)	0.64 kW	0.64 kW	3.4 kW
Working Ambient Temperature *	5 ~ 35 °C	5 ~ 35 °C	5 ~ 35 °C
Working Ambient Pressure	0.1 MPa	0.1 MPa	0.1 MPa
Relative Humidity (Non-Condensing)	≤ 80%	≤ 80%	≤ 80%
Max. Acoustic Noise	92 dB	92 dB	92 dB
Temperature Range of Air Flow at Shaker Inlet	0 ~ 35 °C	0 ~ 35 °C	0 ~ 35 °C
Air Line Supply Required (Compressed Air Supply)	6.9 bar	6.9 bar	6.9 bar
Input Voltage (Standard)	380 VAC, 50 Hz, 3 Phase		
Power Requirements	6 kVA	7.5 kVA	17 kVA

\*Full power to 35 °C, derate at 2% per °C to 50 °C

# M SERIES

## Vibration System Force Rating from 1,000 kgf to 7,000 kgf

Ideal for testing medium to large sized electronic assemblies, automotive parts, aviation and avionics parts.

The "M" Series is designed to meet military and international test standards including MIL, ASTM, IEC, ISO, BS, and JIS. A wide diameter armature with high cross-axial stiffness will allow using a proportioned head expander to test multiple specimens simultaneously yet achieving good vibration transmissibility ratio.

Other test requirements including transportation vibration simulation, combined vibration-climatic test and seismic simulations for small size components can easily be fulfilled by the "M" Series.



### FEATURES

#### THE PERFORMANCE

- Specimen payload up to 1,000 kg
- Excellent random performance meeting ISO standard with 3 sigma peak current rating
- Armature diameters range from 240 mm to 480 mm
- Up to 51 mm continuous displacement
- Test frequency up to 4,000 Hz

#### THE SHAKER

- Rugged trunnion design with bearing guidance
- Air bag or elastomer isolator built-in reducing dynamic floor stress
- Light weight composite armature coil for high acceleration performance
- Flexure suspension system with high cross axial stiffness

#### THE AMPLIFIER

- Integrated with new Intelligent Power Amplifier
- New design with High Speed IGBT technology
- Compact sized power module with large output (30 kVA each)
- High modulation switching frequency
- High signal to noise ratio
- Dynamic fault current error control protection
- Complete digital control

#### THE ACCESSORIES

- Air load support for armature centering
- Dynamic and static armature centering available
- Rotary worm-gear built-in for uni-base slip table
- Thermal barrier for combined climatic chamber test available
- Remote control capabilities available

### BENEFITS

- Simple system operation
- Intelligent PLC control and monitoring system
- High energy conversion efficiency (greater than 90%)
- Reasonably priced optimal performance system for major test standards
- Compact shaker and amplifier size saving valuable floor space
- Compatible with any vibration controller
- Remote control panel via Ethernet cable connections
- Low profile body design ready for chamber integration
- Integration with unibase or standalone slip table
- Shaker air cooled by rugged outdoor blower for continuous long period operation
- Air cooled amplifier power electronics for safe and reliable operation
- Ethernet port available for data exchange
- All-encompassing fuse protection design for high current system components
- Detailed scope of system interlock protections
- Complies with USA, European and international safety and EMC regulations
- Simple initial self-system setup
- Interactive diagnostic "System Status" on touch screen
- Easy maintenance and rapid servicing
- Worldwide spare parts support



<b>SPECIFICATIONS - M SERIES</b>					
<b>SYSTEM MODEL</b>	<b>MPA403 / M124M</b>	<b>IPA30L / M232A</b>	<b>IPA60L / M437A</b>	<b>IPA90L / M544A</b>	<b>IPA90L / M748A</b>
Sine Force	1,000 kgf	2,000 kgf	4,000 kgf	5,000 kgf	7,000 kgf
Random Force	1,000 kgf	2,000 kgf	4,000 kgf	5,000 kgf	7,000 kgf
Shock Force (½ Sine)	2,000 kgf	4,000 kgf	8,000 kgf	10,000 kgf	14,000 kgf
Usable Frequency Range	DC to 4,000 Hz	DC to 3,000 Hz	DC to 2,500 Hz	DC to 2,700 Hz	DC to 2,500 Hz
Continuous / Shock Displacement (1)	51 mm / 51 mm	51 mm / 51 mm	51 mm / 51 mm	51 mm / 51 mm	51 mm / 63.5 mm
Max. Velocity (Sine)	2.0 m/s	2.0 m/s	2.0 m/s	2.0 m/s	2.0 m/s
Max. Acceleration (Sine)	981 m/s <sup>2</sup>	981 m/s <sup>2</sup>	981 m/s <sup>2</sup>	981 m/s <sup>2</sup>	981 m/s <sup>2</sup>
<b>SHAKER UNIT</b>	<b>M124M</b>	<b>M232A</b>	<b>M437A</b>	<b>M544A</b>	<b>M748A</b>
Armature Diameter	240 mm	320 mm	370 mm	445 mm	480 mm
Effective Moving Element Mass	10 kg	20 kg	34 kg	50 kg	64 kg
Load Attachment Points	16 stainless steel inserts	16 stainless steel inserts	16 stainless steel inserts	16 stainless steel inserts	16 stainless steel inserts
Inserts Size (Standard)	M10	M10	M10	M12	M12
Grid Pattern (Diameter, Circle)	8 on Ø 100mm; 8 on Ø 200mm	8 on Ø 120mm; 8 on Ø 250 mm	8 on Ø 150mm; 8 on Ø 300 mm	8 on Ø 200mm; 8 on Ø 400 mm	8 on Ø 200mm; 8 on Ø 400 mm
Nominal, Bare Table (2)	3,600 Hz	2,500 Hz	2,250 Hz	2,400 Hz	2,100 Hz
Max. Static Payload	140 kg	300 kg	500 kg	1,000 kg	1,000 kg
Natural Frequency (Thrust Axis)	<5 Hz	<5 Hz	<5 Hz	<5 Hz	<5 Hz
Stray Flux Density (3)	Less than 10 gauss	Less than 10 gauss	Less than 10 gauss	Less than 10 gauss	Less than 10 gauss
Dimensions (Uncrated) (L x W x H)	1061 x 730 x 784 mm	1189 x 780 x 1020 mm	1336 x 860 x 1118 mm	1620 x 1202 x 1313 mm	1620 x 1202 x 1390 mm
Weight (Uncrated)	960 kg	1,650 kg	2,470 kg	4,500 kg	4,500 kg
<b>AMPLIFIER UNIT</b>	<b>MPA403</b>	<b>IPA30L</b>	<b>IPA60L</b>	<b>IPA90L</b>	<b>IPA90L</b>
Amplifier Output	13 kVA	30 kVA	60 kVA	90 kVA	90 kVA
Total Harmonic Distortion (At Rated Output)	From DC (0.1Hz) to 500Hz less than 0.5%; From 500Hz to 5,000Hz less than 1.0%	From 5 Hz to 2,500 Hz less than 1.2%; from 2,500 Hz to 3,500 Hz less than 1.5% with resistive load			
Signal-Noise-Ratio	More than 65dB at 100V rms output, 10KΩ input termination with rated resistive load	More than 65 dB at 120 V rms output, 10 kΩ input termination with rated resistive load			
DC Stability	Less than 0.05% of full output voltages with 10% change in line voltage				
Input Drive	4V rms into 10KΩ for full output (120V rms)	2 V rms into 10 kΩ for full output (120 V rms)			
Amplifier Frequency Response (4)	From DC (0.1Hz) to 4,500Hz: ± 3dB; From 10Hz to 3,000Hz: ± 1dB	From 5 Hz to 10 Hz: ± 6 dB; from 10 Hz to 5,000 Hz: ± 3 dB			
Switching Frequency	112 kHz	150 kHz	150 kHz	150 kHz	150 kHz
Max. Output Voltage	120 Vrms	120 Vrms	120 Vrms	120 Vrms	120 Vrms
Max. Output Current Per Module (Continuous / Transient)	50 Arms / 150 Arms	250 Arms / 750 Arms	250 Arms / 750 Arms	250 Arms / 750 Arms	250 Arms / 750 Arms
Amplifier Efficiency	>90%	>90%	>90%	>90%	>90%
Dimensions (Uncrated) (L x W x H)	550 x 800 x 1850 mm	550 x 800 x 1850 mm	550 x 800 x 2070 mm	550 x 800 x 2070 mm	550 x 800 x 2070 mm
Weight (Uncrated)	420 kg	480 kg	515 kg	550 kg	550 kg
<b>BLOWER UNIT</b>	<b>HP-2A</b>	<b>HP-3A</b>	<b>HP-3A</b>	<b>HP-4A</b>	<b>HP-4A</b>
Power Output	4 kW	7.5 kW	7.5 kW	22 kW	22 kW
Air Flow	0.21 m <sup>3</sup> / s	0.467 m <sup>3</sup> / s	0.73 m <sup>3</sup> / s	0.91 m <sup>3</sup> / s	1.035 m <sup>3</sup> / s
Air Pressure	0.058 kgf / cm <sup>2</sup>	0.057 kgf / cm <sup>2</sup>	0.082 kgf / cm <sup>2</sup>	0.079 kgf / cm <sup>2</sup>	0.095 kgf / cm <sup>2</sup>
Dimensions (Uncrated) (L x W x H)	748 x 604 x 1450 mm	945 x 693 x 1466 mm	945 x 693 x 1466 mm	930 x 1143 x 2185 mm	930 x 1143 x 2185 mm
Weight (Uncrated)	115 kg	175 kg	175 kg	370 kg	370 kg

# M SERIES

Specifications are correct at the time of publication. In keeping with our commitment to continuous product improvement, the information herewith is subject to change. ETS reserves the rights to amend specifications without prior notice.

**REMARKS:**

1. Test payload should be less than 10% of shaker weight
2. First resonance frequency at  $\pm 5\%$  tolerance
3. Measured at 152mm above armature table. Contact us for lower gauss level requirement.
4. Sine mode, resistive load

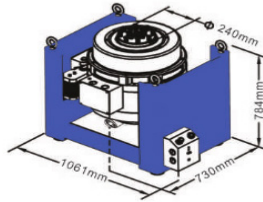
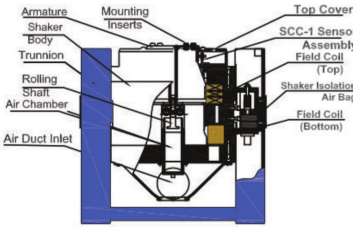

M124M

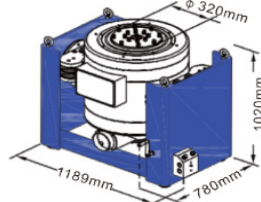

M232A

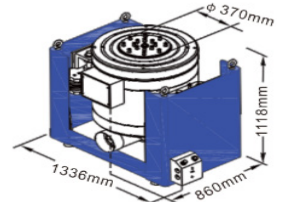

M437A

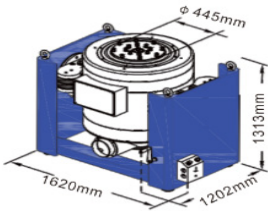

M544A

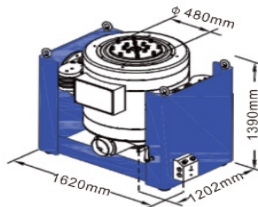

M748A



IPA Series Amplifier

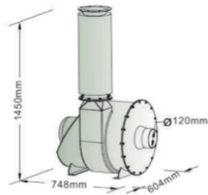

HP-2A

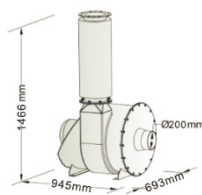

HP-3A

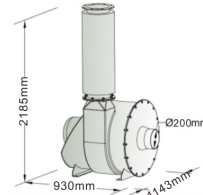

HP-4A

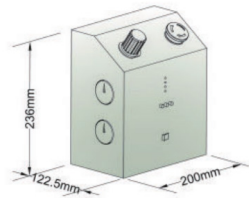

Servo Control Console (SCC-1 Unit)



Remote Control Panel (RCP)

SYSTEM OPTIONS	MPA403 / M124M	IPA30L / M232A	IPA60L / M437A	IPA90L / M544A	IPA90L / M748A
Table Inserts					
M10	●	●	●	○	○
M12	○	○	○	●	●
1/2" UNC	○	○	○	○	○
3/8" UNC	○	○	○	○	○
Internal Load Support	●	●	●	●	●
Thermal Barrier	○	○	○	○	○
Unibase Slip Table	○	○	○	○	○
Air Caster	○	○	○	○	○
Degauss Coil	●	●	●	●	●
Electrical Rotation Unit	-	○	○	○	○
Air Isolation Trunnion	●	●	●	●	●
Geared Aided Rotation (Ratchet Crank)	○	●	●	○	○
Geared Aided Rotation (Chain Wheel Reducer)	-	○	○	●	●
Servo Control Console (SCC-1 Unit)	●	●	●	●	●
Remote Control Panel (RCP)	○	○	○	○	○

● Standard ○ Optional - Not Available

OPERATING ENVIRONMENTAL DATA	MPA403 / M124M	IPA30L / M232A	IPA60L / M437A	IPA90L / M544A	IPA90L / M748A
Max. Heat Rejection to Air (Shaker)	0.8 kW	1.5 kW	2.76 kW	3.5 kW	4.6 kW
Max. Heat Rejection to Air (Amplifier)	2.03 kW	3.15 kW	5.63 kW	7.5 kW	9.9 kW
Max. Heat Rejection to Air (Blower)	3.4 kW	6.38 kW	6.38 kW	12.75 kW	12.75 kW
Working Ambient Temperature *	5 ~ 35 °C	5 ~ 35 °C	5 ~ 35 °C	5 ~ 35 °C	5 ~ 35 °C
Working Ambient Pressure	0.1 MPa	0.1 MPa	0.1 MPa	0.1 MPa	0.1 MPa
Relative Humidity (Non-Condensing)	≤ 80%	≤ 80%	≤ 80%	≤ 80%	≤ 80%
Max. Acoustic Noise	92 dB	92 dB	92 dB	92 dB	92 dB
Temperature Range of Air Flow at Shaker Inlet	0 ~ 35 °C	0 ~ 35 °C	0 ~ 35 °C	0 ~ 35 °C	0 ~ 35 °C
Air Line Supply Required (Compressed Air Supply)	6.9 bar	6.9 bar	6.9 bar	6.9 bar	6.9 bar
Input Voltage (Standard)	380 VAC, 50 Hz, 3 Phase				
Power Requirements	28 kVA	40 kVA	68 kVA	97 kVA	112 kVA

\*Full power to 35 °C, derate at 2% per °C to 50 °C

# LS SERIES

## Vibration System Force Rating from 2,000 kgf to 7,000 kgf

Ideal for test applications such as packaging testing and vehicle testing.

The Long-Stroke (LS) Series vibration testing systems are designed for long-stroke displacement test requirements normally performed by hydraulic shakers.

Compared to a hydraulic shaker where maximum test frequency is typically around 400 Hz, the Long-Stroke Series is capable to testing up to 2,700 Hz with maximum acceleration of 100g (bare table) bounded by 2.0 m/s maximum velocity.

This provides users time and cost savings for wide test requirements.



## FEATURES

### THE PERFORMANCE

- Specimen payload up to 1,000 kg
- Excellent random performance meeting ISO standard with 3 sigma peak current rating
- Armature diameters range from 320 mm to 480 mm
- Up to 100 mm continuous displacement
- Test frequency up to 2,700 Hz

### THE SHAKER

- Rugged trunnion design with bearing guidance
- Air bag isolator built-in reducing dynamic floor stress
- Dual layer reinforced armature for high acceleration performance
- Roller bearing flexure with load support bearing suspension system achieving high cross-axial stiffness

### THE AMPLIFIER

- Integrated with new Intelligent Power Amplifier
- New design with High Speed IGBT technology
- Compact sized power module with large output (60 kVA each)
- High modulation switching frequency
- High signal to noise ratio
- Dynamic fault current error control protection
- Complete digital control

### THE ACCESSORIES

- Air load support for armature centering
- Dynamic and static armature centering available
- Geared aided rotation for uni-base slip table
- Thermal barrier for combined climatic chamber test available
- Remote control capabilities available

## BENEFITS

- Simple system operation
- Intelligent PLC control and monitoring system
- High-energy conversion efficiency (greater than 90%)
- Reasonably priced optimal performance system for major test standards
- Compact shaker and amplifier size saving valuable floor space
- Shaker air-cooled by rugged outdoor blower for continuous long-period operation
- Air cooled amplifier for safe and reliable operation
- Ethernet port available for data exchange
- All-encompassing fuse protection designed for high current system components
- Detailed scope of system interlock protections
- Complies with USA, European and international safety and EMC regulations
- Compatible with all vibration controllers
- Remote control panel via Ethernet cable connections
- Low-profile body design ready for chamber integration
- Integration with unibase or standalone slip table
- Simple initial self-system setup
- Interactive diagnostic "System Status" displayed on touch screen
- Easy maintenance and rapid servicing
- Worldwide spare parts support

<b>SPECIFICATIONS - LS SERIES</b>				
<b>SYSTEM MODEL</b>	<b>IPA60H / LS232A</b>	<b>IPA60H / LS437A</b>	<b>IPA60H / LS544A</b>	<b>IPA120H / LS748A</b>
Sine Force	2,000 kgf	4,000 kgf	5,000 kgf	7,000 kgf
Random Force	2,000 kgf	4,000 kgf	5,000 kgf	7,000 kgf
Shock Force (½ Sine)	4,000 kgf	8,000 kgf	10,000 kgf	14,000 kgf
Usable Frequency Range	DC to 2,700 Hz	DC to 2,500 Hz	DC to 2,700 Hz	DC to 2,500 Hz
Continuous / Shock Displacement (1)	80 mm / 100 mm	80 mm / 100 mm	80 mm / 100 mm	63.5 mm / 76 mm
Max. Velocity (Sine)	2.0 m/s	2.0 m/s	2.0 m/s	2.0 m/s
Max. Acceleration (Sine)	784 m/s <sup>2</sup>	784 m/s <sup>2</sup>	784 m/s <sup>2</sup>	784 m/s <sup>2</sup>
<b>SHAKER UNIT</b>	<b>LS232A</b>	<b>LS437A</b>	<b>LS544A</b>	<b>LS748A</b>
Armature Diameter	320 mm	370 mm	445 mm	480 mm
Effective Moving Element Mass	22 kg	37 kg	62 kg	80 kg
Load Attachment Points	16 stainless steel inserts	16 stainless steel inserts	16 stainless steel inserts	16 stainless steel inserts
Inserts Size (Standard)	M10	M10	M12	M12
Grid Pattern (Diameter, Circle)	8 on Ø 120mm; 8 on Ø 250mm	8 on Ø 150mm; 8 on Ø 300mm	8 on Ø 200mm; 8 on Ø 400mm	8 on Ø 200mm; 8 on Ø 400mm
Nominal, Bare Table (2)	2,300 Hz	2,100 Hz	2,100 Hz	2,100 Hz
Max. Static Payload	300 kg	500 kg	1,000 kg	1,000 kg
Natural Frequency (Thrust Axis)	< 5 Hz	< 5 Hz	< 5 Hz	< 5 Hz
Stray Flux Density (3)	Less than 10 gauss	Less than 10 gauss	Less than 10 gauss	Less than 10 gauss
Dimensions (Uncrated) (L x W x H)	1189 x 775 x 1078 mm	1336 x 865 x 1204 mm	1621 x 1102 x 1363 mm	1620 x 1202 x 1390 mm
Weight (Uncrated)	1,700 kg	2,800 kg	4,500 kg	4,500 kg
<b>AMPLIFIER UNIT</b>	<b>IPA60H</b>	<b>IPA60H</b>	<b>IPA60H</b>	<b>IPA120H</b>
Amplifier Output	60 kVA	60 kVA	60 kVA	120 kVA
Total Harmonic Distortion (At Rated Output)	From 5Hz to 2,500Hz less than 1.2%; From 2,500Hz to 3,500Hz less than 1.5% with resistive load			
Signal-Noise-Ratio	More than 70 dB at 320 V rms output, 10KΩ input termination with rated resistive load			
DC Stability	Less than 0.05% of full output voltage with 10% changes in line voltage			
Input Drive	2 V rms into 10KΩ for full output (320V rms)			
Amplifier Frequency Response (4)	From 5Hz to 10Hz: ± 6dB; From 10Hz to 5,000Hz: ± 3dB			
Switching Frequency	150 kHz	150 kHz	150 kHz	150 kHz
Max. Output Voltage	320V rms	320V rms	320V rms	320V rms
Max. Output Current Per Module (Continuous / Transient)	190 A rms / 570 A rms	190 A rms / 570 A rms	190 A rms / 570 A rms	190 A rms / 570 A rms
Amplifier Efficiency	> 90%	> 90%	> 90%	> 90%
Dimensions (Uncrated) (L x W x H)	550 x 800 x 1850 mm	550 x 800 x 2070 mm	550 x 800 x 2070 mm	550 x 800 x 2070 mm
Weight (Uncrated)	500 kg	500 kg	500 kg	550 kg
<b>BLOWER UNIT</b>	<b>HP-3A</b>	<b>HP-3A</b>	<b>HP-4A</b>	<b>HP-4A</b>
Power Output	7.5 kW	7.5 kW	22 kW	22 kW
Air Flow	0.476 m <sup>3</sup> / s	0.745 m <sup>3</sup> / s	0.91 m <sup>3</sup> / s	1.035 m <sup>3</sup> / s
Air Pressure	0.056 kgf / cm <sup>2</sup>	0.082 kgf / cm <sup>2</sup>	0.079 kgf / cm <sup>2</sup>	0.095 kgf / cm <sup>2</sup>
Dimensions (Uncrated) (L x W x H)	945 x 693 x 1466 mm	945 x 693 x 1466 mm	930 x 1143 x 2185 mm	930 x 1143 x 2185 mm
Weight (Uncrated)	175 kg	175 kg	370 kg	370 kg

Specifications are correct at the time of publication. In keeping with our commitment to continuous product improvement, the information herewith is subject to change. ETS reserves the rights to amend specifications without prior notice.

#### REMARKS:

1. Test payload should be less than 10% of shaker weight
2. First resonance frequency at ± 5% tolerance
3. Measured at 152mm above armature table. Contact us for lower gauss level requirement.
4. Sine mode, resistive load

# LS SERIES

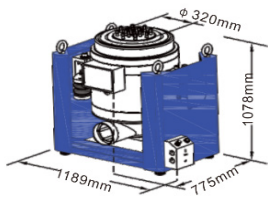

LS232A

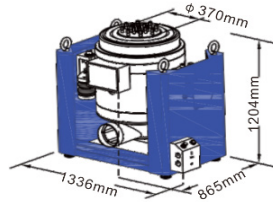

LS437A

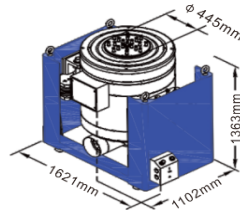

LS544A

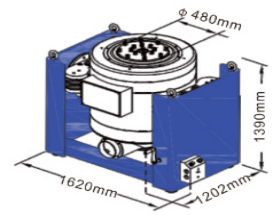

LS748A

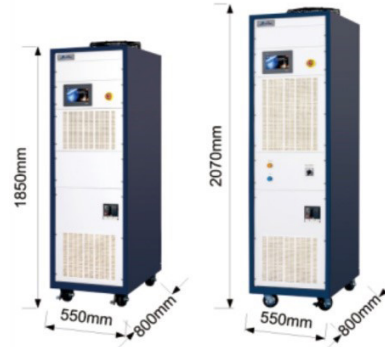
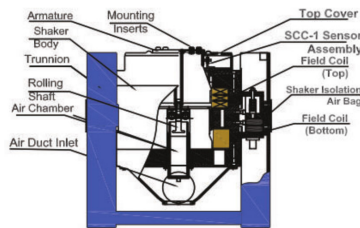

IPA Series Amplifier

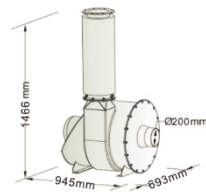

HP-3A

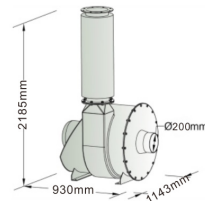

HP-4A

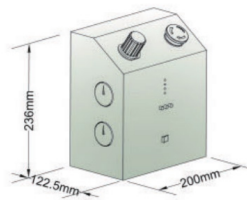

Servo Control Console  
(SCC-1 Unit)



Remote Control Panel  
(RCP)

SYSTEM OPTIONS	IPA60H / LS232A	IPA60H / LS437A	IPA60H / LS544A	IPA120H / LS748A
Table Inserts				
M10	●	●	○	○
M12	○	○	●	●
1/2" UNC	○	○	○	○
3/8" UNC	○	○	○	○
Internal Load Support	●	●	●	●
Thermal Barrier	○	○	○	○
Unibase Slip Table	○	○	○	○
Air Caster	○	○	○	○
Degauss Coil	●	●	○	○
Electrical Rotation Unit	-	-	○	○
Air Isolation Trunnion	●	●	●	●
Geared Aided Rotation (Ratchet Crank)	●	●	○	○
Geared Aided Rotation (Chain Wheel Reducer)	○	○	●	●
Servo Control Console (SCC-1 Unit)	●	●	●	●
Remote Control Panel (RCP)	○	○	○	○

● Standard ○ Optional - Not Available

OPERATING ENVIRONMENTAL DATA	IPA60H / LS232A	IPA60H / LS437A	IPA60H / LS544A	IPA120H / LS748A
Max. Heat Rejection to Air (Shaker)	1.5 kW	2.23 kW	3.5 kW	4.6 kW
Max. Heat Rejection to Air (Amplifier)	3.15 kW	4.35 kW	7.5 kW	9.9 kW
Max. Heat Rejection to Air (Blower)	6.38 kW	6.38 kW	12.75 kW	12.75 kW
Working Ambient Temperature *	5 ~ 35 °C	5 ~ 35 °C	5 ~ 35 °C	5 ~ 35 °C
Working Ambient Pressure	0.1 MPa	0.1 MPa	0.1 MPa	0.1 MPa
Relative Humidity (Non-Condensing)	≤ 80%	≤ 80%	≤ 80%	≤ 80%
Max. Acoustic Noise	92 dB	92 dB	92 dB	92 dB
Temperature Range of Air Flow at Shaker Inlet	0 ~ 35 °C	0 ~ 35 °C	0 ~ 35 °C	0 ~ 35 °C
Air Line Supply Required (Compressed Air Supply)	6.9 bar	6.9 bar	6.9 bar	6.9 bar
Input Voltage (Standard)	380 VAC, 50 Hz, 3 Phase			
Power Requirements	40 kVA	68 kVA	97 kVA	112 kVA

\*Full power to 35 °C, derate at 2% per °C to 50 °C

# H SERIES

## Vibration System Force Rating from 8,000 kgf to 30,000 kgf

Ideal for screening of large sized assemblies with high acceleration test requirements.

The "H" Series also meets typical vibration test requirements of other large sized electronic assemblies, automotive parts, aviation, avionics parts, satellites, aerospace and military systems.

The "H" Series vibration is designed to meet military and international test standards including MIL, ASTM, IEC, ISO, BS and JIS. A wide diameter armature with high cross-axial stiffness will allow for using a proportioned head expander to test multiple specimens simultaneously yet achieving good vibration transmissibility ratio.

Other test requirements including transportation vibration simulation, combined vibration-climatic test and seismic simulations for large size components can easily be fulfilled by the "H" Series. Options are available to meet the most stringent test requirements for hazardous or explosive materials.

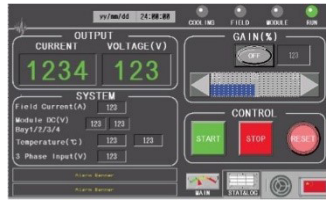

### FEATURES

#### THE PERFORMANCE

- Specimen payload up to 5,000 kg
- Excellent random performance meeting ISO standard with 3 sigma peak current rating
- Armature diameters range from 445 mm to 800 mm
- Up to 63.5 mm continuous displacement
- Test frequency up to 2,500 Hz

#### THE SHAKER

- Separated water inlets and outlets current leads to the armature coil
- Dual bearing shaft built-in for load support
- High efficient water-cooled armature coil
- Special copper flexure suspension system with high cross axial stiffness
- Closed loop water cooling system

#### THE AMPLIFIER

- Integrated with new Intelligent Power Amplifier
- New design with High Speed IGBT technology
- Compact sized power module with large output
- High modulation switching frequency
- High signal to noise ratio
- Dynamic fault current error control protection
- Complete digital control

#### THE ACCESSORIES

- Dynamic and static armature centering available
- Geared aided rotation built-in for uni-base slip table
- Thermal barrier for combined climatic chamber test available
- Remote control capabilities available

### BENEFITS

- Simple system operation
- Intelligent PLC control and monitoring system
- High energy conversion efficiency (greater than 90%)
- Reasonably priced optimal performance system for major test standards
- Compact shaker and amplifier size saving valuable floor space
- Compatible with any vibration controller
- Remote control panel via Ethernet cable connections
- Low profile body design ready for chamber integration
- Integration with unibase or standalone slip table
- Shaker water cooled by water cooling system for continuous long period operation
- Air cooled amplifier power electronics for safe and reliable operation
- Ethernet port available for data exchange
- All-encompassing fuse protection design for high current system components
- Detailed scope of system interlock protections
- Complies with USA, European and international safety and EMC regulations
- Simple initial self-system setup
- Interactive diagnostic "System Status" on touch screen
- Easy maintenance and rapid servicing
- Worldwide spare parts support



<b>SPECIFICATIONS - H SERIES</b>					
<b>SYSTEM MODEL</b>	<b>IPA120L/H844A</b>	<b>IPA150L/H1248A</b>	<b>IPA180L/H1859A</b>	<b>IPA360H/H2565A</b>	<b>IPA540H/H3580A</b>
Sine Force	8,000 kgf	10,000 kgf	16,000 kgf	20,000 kgf	30,000 kgf
Random Force	8,000 kgf	10,000 kgf	16,000 kgf	20,000 kgf	27,000 kgf
Shock Force (½ Sine)	16,000 kgf	20,000 kgf	32,000 kgf	40,000 kgf	60,000 kgf
Usable Frequency Range	5 ~ 2,500 Hz	5 ~ 2,500 Hz	5 ~ 2,000 Hz	5 ~ 2,000 Hz	5 ~ 1,700 Hz
Continuous / Shock Displacement (1)	63.5 mm / 76 mm	51 mm (Opt.: 63.5 mm) / 76 mm	51 mm / 51 mm	63.5 mm / 76 mm	51 mm / 51 mm
Max. Velocity (Sine)	2.0 m/s	2.0 m/s	2.0 m/s	2.0 m/s	2.0 m/s
Max. Acceleration (Sine)	981 m/s <sup>2</sup>	981 m/s <sup>2</sup>	981 m/s <sup>2</sup>	981 m/s <sup>2</sup>	981 m/s <sup>2</sup>
<b>SHAKER UNIT</b>	<b>H844A</b>	<b>H1248A</b>	<b>H1859A</b>	<b>H2565A</b>	<b>H3580A</b>
Armature Diameter	445 mm	480 mm	590 mm	650 mm	800 mm
Effective Moving Element Mass	60 kg	85 kg	130 kg	200 kg	300 kg
Load Attachment Points	16 stainless steel inserts	16 stainless steel inserts	24 stainless steel inserts	32 stainless steel inserts	40 stainless steel inserts
Inserts Size (Standard)	M12	M12	M12	M16	M20
Grid Pattern (Diameter, Circle)	8 on Ø 200mm; 8 on Ø 400mm		8 on Ø 254mm; 8 on Ø 406.4mm; 8 on Ø 558.8mm	16 on Ø 450mm; 16 on Ø 610 mm	8 on Ø 450mm; 16 on Ø 610 mm; 16 on Ø 760 mm
Nominal, Bare Table (2)	2,200 Hz	2,100 Hz	1,800 Hz	1,600 Hz	1,450 Hz
Max. Static Payload	800 kg	1,100 kg	1,600 kg	2,000 kg	5,000 kg
Natural Frequency (Thrust Axis)	< 3 Hz	< 5 Hz	< 5 Hz	< 5 Hz	< 5 Hz
Stray Flux Density (3)	Less than 10 gauss	Less than 10 gauss	Less than 10 gauss	Less than 20 gauss	Less than 20 gauss
Dimensions (Uncrated) (L x W x H)	1392 x 1316 x 1198 mm	1590 x 1346 x 1393 mm	1963 x 1413 x 1536 mm	1680 x 2410 x 1600 mm	2953 x 1920 x 1951 mm
Weight (Uncrated)	3,200 kg	4,500 kg	9,000 kg	25,000 kg	30,000 kg
<b>AMPLIFIER UNIT</b>	<b>IPA120L</b>	<b>IPA150L</b>	<b>IPA180L</b>	<b>IPA360H</b>	<b>IPA540H</b>
Amplifier Output	120 kVA	150 kVA	180 kVA	360 kVA	540 kVA
Total Harmonic Distortion (At Rated Output)	From 5 Hz to 2,500 Hz less than 1.2%; from 2,500 Hz to 3,500 Hz less than 1.5% with resistive load				
Signal-Noise-Ratio	More than 65 dB at 120 V rms output, 10 kΩ input termination with rated resistive load			More than 70 dB at 320 V rms output, 10 kΩ input termination with rated resistive load	
DC Stability	Less than 0.05% of full output voltages with 10% change in line voltage				
Input Drive	2 V rms into 10 kΩ for full output (120 V rms)			2 V rms into 10 kΩ for full output (320 V rms)	
Amplifier Frequency Response (4)	From 5 Hz to 10 Hz: ±6 dB; from 10 Hz to 5,000 Hz: ±3 dB				
Switching Frequency	150 kHz	150 kHz	150 kHz	150 kHz	150 kHz
Max. Output Voltage	120 Vrms	120 Vrms	120 Vrms	320 Vrms	320 Vrms
Max. Output Current Per Module (Continuous / Transient)	250 Arms / 750 Arms	250 Arms / 750 Arms	250 Arms / 750 Arms	190 Arms / 570 Arms	190 Arms / 570 Arms
Amplifier Efficiency	> 90%	> 90%	> 90%	> 90%	> 90%
Dimensions (Uncrated) (L x W x H)	1100 x 800 x 2060 mm	1650 x 800 x 2070 mm	1650 x 800 x 2070 mm	1650 x 800 x 2070 mm	2200 x 800 x 2070 mm
Weight (Uncrated)	1,350 kg	1,950 kg	2,250 kg	1,750 kg	2,650 kg
<b>COOLING UNIT</b>	<b>CU-0</b>	<b>CU-1</b>	<b>CU-2</b>	<b>CU-3</b>	<b>CU-4</b>
Power Requirement	6 kW	8 kW	10 kW	15 kW	18 kW
Facility Cooling Water Flow	135 L/min	180 L/min	280 L/min	345 L/min	400 L/min
Facility Cooling Water Pressure Drop	0.25 ~ 0.4 MPa	0.25 ~ 0.4 MPa	0.25 ~ 0.4 MPa	0.25 ~ 0.4 MPa	0.25 ~ 0.4 MPa
Dimensions (Uncrated) (L x W x H)	1180 x 1780 x 1850 mm	1180 x 1780 x 1850 mm	1180 x 1780 x 1850 mm	1350 x 2000 x 2070 mm	1350 x 2000 x 2070 mm
Weight (Uncrated)	550 kg	630 kg	750 kg	1,000 kg	1,320 kg

Specifications are correct at the time of publication. In keeping with our commitment to continuous product improvement, the information herewith is subject to change. ETS reserves the rights to amend specifications without prior notice.

#### REMARKS:

1. Test payload should be less than 10% of shaker weight
2. First resonance frequency at ± 5% tolerance
3. Measured at 152mm above armature table. Contact us for lower gauss level requirement.
4. Sine mode, resistive load

# H SERIES

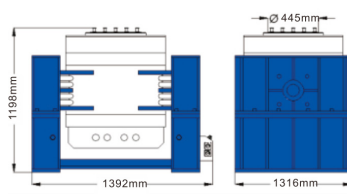
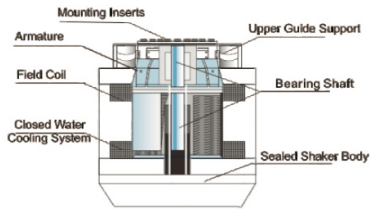

H844A

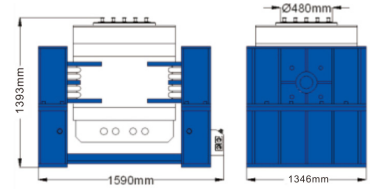

H1248A

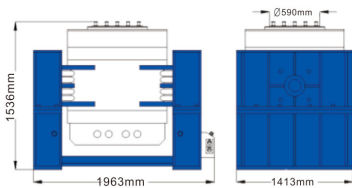

H1859A

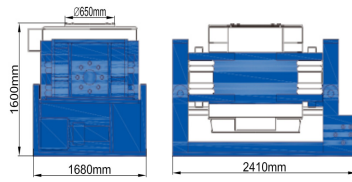

H2565A

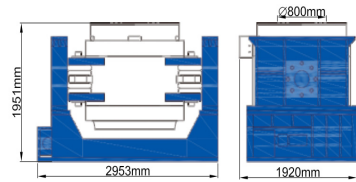

H3580A



IPA Series Amplifier

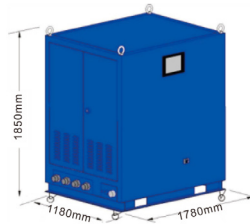

CU-0 CU-1 CU-2

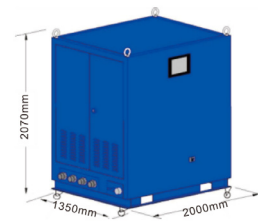

CU-3 CU-4

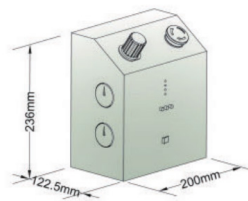

Servo Control Console (SCC-1 Unit)



Remote Control Panel (RCP)

SYSTEM OPTIONS	IPA120L/H844A	IPA150L/H1248A	IPA180L/H1859A	IPA360H/H2565A	IPA540H/H3580A
Table Inserts					
M10	o	o	o	o	o
M12	●	●	●	●	●
1/2" UNC	o	o	o	o	o
3/8" UNC	o	o	o	o	o
Internal Load Support	●	●	●	●	●
Thermal Barrier	o	o	o	o	o
Unibase Slip Table	o	o	o	o	o
Air Caster	o	o	o	o	o
Degauss Coil	●	●	●	●	●
Electrical Rotation Unit	o	o	o	o	o
Air Isolation Trunnion	●	●	●	●	●
Geared Aided Rotation (Chain Wheel Reducer)	●	●	●	●	●
Servo Control Console (SCC-1 Unit)	●	●	●	●	●
Remote Control Panel (RCP)	o	o	o	o	o

● Standard   o Optional   - Not Available

OPERATING ENVIRONMENTAL DATA	IPA120L/H844A	IPA150L/H1248A	IPA180L/H1859A	IPA360H/H2565A	IPA540H/H3580A
Max. Heat Rejection to Air (Shaker)	5.5 kW	8.6 kW	11.8 kW	15.8 kW	18.7 kW
Max. Heat Rejection to Air (Amplifier)	7.2 kW	7.5 kW	12.2 kW	14.1 kW	18.5 kW
Max. Heat Rejection to Air (Cooling Unit)	1.8 kW	2.6 kW	5.1 kW	7.6 kW	8.2 kW
Working Ambient Temperature *	5 ~ 35 °C	5 ~ 35 °C	5 ~ 35 °C	5 ~ 35 °C	5 ~ 35 °C
Working Ambient Pressure	-	0.1 MPa	0.1 MPa	0.1 MPa	0.1 MPa
Relative Humidity (Non-Condensing)	≤ 80%	≤ 80%	≤ 80%	≤ 80%	≤ 80%
Max. Acoustic Noise	92 dB	92 dB	92 dB	92 dB	92 dB
Max. Temperature of Facility Cooling Water Inlet	27 °C	27 °C	27 °C	27 °C	27 °C
Air Line Supply Required (Compressed Air Supply)	6.9 bar	6.9 bar	6.9 bar	6.9 bar	6.9 bar
Input Voltage (Standard)	380 VAC, 50 Hz, 3 Phase				
Power Requirements	136 kVA	198 kVA	288 kVA	375 kVA	468 kVA

\*Full power to 35 °C, derate at 2% per °C to 50 °C

# I SERIES

## Vibration System Force Rating from 4,000 kgf to 16,000 kgf

Ideal for screening of medium sized assemblies with extreme high acceleration test level and high frequency range.

The "I" Series exceeds typical vibration test requirements of other medium to large sized electronic assemblies, automotive parts, aviation and avionics parts.

The "I" Series is designed to meet military and international test standards including MIL, ASTM, IEC, ISO, BS and JIS.

The Extreme Acceleration Shaker Y-Ring (EAS-Y Ring) armature is a revolutionary design which will allow for using a proportioned head expander to test multiple specimens simultaneously at extreme high acceleration level. Other test requirements including transportation vibration simulation combined vibration-climatic test and seismic simulations for small size components can easily be fulfilled by the ETS "I" Series.

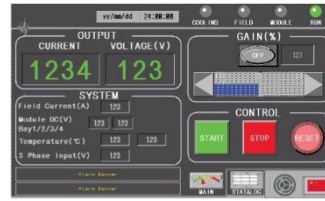

### FEATURES

#### THE PERFORMANCE

- Specimen payload up to 1,200 kg
- Excellent random performance meeting ISO standard with 3 sigma peak current rating
- Armature diameters range from 370 mm to 590 mm
- Up to 51 mm continuous displacement
- Test frequency up to 2,800 Hz

#### THE SHAKER

- Light weight solid armature for high acceleration performance (No Multiple Windings)
- Rugged trunnion design with bearing guidance
- Air load support for armature centering
- Air bag isolator built-in reducing dynamic floor stress

#### THE AMPLIFIER

- Integrated with new Intelligent Power Amplifier
- New design with High Speed IGBT technology
- Compact sized power module with large output
- High modulation switching frequency
- High signal to noise ratio
- Dynamic fault current error control protection
- Complete digital control

#### THE ACCESSORIES

- Dynamic and static armature centering available
- Geared aided rotation built-in for uni-base slip table
- Thermal barrier for combined climatic chamber test available
- Remote control capabilities available

### BENEFITS

- Simple system operation
- Intelligent PLC control and monitoring system
- High energy conversion efficiency (greater than 90%)
- Reasonably priced optimal performance system for major test standards
- Compact shaker and amplifier size saving valuable floor space
- Compatible with any vibration controller
- Remote control panel via Ethernet cable connections
- Low profile body design ready for chamber integration
- Integration with unibase or standalone slip table
- Shaker water cooled by water cooling system for continuous long period operation
- Air cooled amplifier power electronics for safe and reliable operation
- Ethernet port available for data exchange
- All-encompassing fuse protection design for high current system components
- Detailed scope of system interlock protections
- Complies with USA, European and international safety and EMC regulations
- Simple initial self-system setup
- Interactive diagnostic "System Status" on touch screen
- Easy maintenance and rapid servicing
- Worldwide spare parts support

<b>SPECIFICATIONS - I SERIES</b>					
<b>SYSTEM MODEL</b>	<b>IPA120H/I537M</b>	<b>IPA180H/I1537M</b>	<b>IPA240H/I1045M</b>	<b>IPA300H/I1045M</b>	<b>IPA360H/I1859A</b>
Sine Force	4,000 kgf	5,000 kgf	8,000 kgf	10,000 kgf	16,000 kgf
Random Force	4,000 kgf	5,000 kgf	8,000 kgf	10,000 kgf	16,000 kgf
Shock Force (½ Sine)	10,000 kgf	12,500 kgf	20,000 kgf	20,000 kgf	40,000 kgf
Usable Frequency Range	DC ~ 2,500 Hz (Opt 2,800 Hz)	5 ~ 2,500 Hz	DC ~ 2,000 Hz	5 ~ 2,000 Hz	DC ~ 2,000 Hz
Continuous / Shock Displacement (1)	51 mm / 76 mm	51 mm / 76 mm	51 mm / 76 mm	51 mm / 76 mm	51 mm / 65 mm
Max. Velocity (Sine/Shock)	2.0 m/s / 3.5 m/s	2.0 m/s / 3.5 m/s	2.0 m/s / 3.5 m/s	2.0 m/s / 3.5 m/s	2.0 m/s / 3.5 m/s
Max. Acceleration (Sine / Random)	1,275 m/s <sup>2</sup> / 981 m/s <sup>2</sup>	1,275 m/s <sup>2</sup> / 981 m/s <sup>2</sup>	1,275 m/s <sup>2</sup> / 981 m/s <sup>2</sup>	1,275 m/s <sup>2</sup> / 981 m/s <sup>2</sup>	1,177 m/s <sup>2</sup> / 981 m/s <sup>2</sup>
<b>SHAKER UNIT</b>	<b>I537M</b>	<b>I537M</b>	<b>I1045M</b>	<b>I1045M</b>	<b>I1859A</b>
Armature Diameter	370 mm	370 mm	445 mm	445 mm	590 mm
Effective Moving Element Mass	30 kg	30 kg	60 kg	60 kg	145 kg
Load Attachment Points	16 stainless steel inserts	16 stainless steel inserts	28 stainless steel inserts	28 stainless steel inserts	24 stainless steel inserts
Inserts Size (Standard)	M10	M10	M12	M12	M12
Grid Pattern (Diameter, Circle)	8 on Ø 150mm; 8 on Ø 300 mm		4 on Ø 100mm; 8 on Ø 200mm; 8 on Ø 300mm; 8 on Ø 400mm		8 on Ø 254mm; 8 on Ø 406.4mm; 8 on Ø 558.8mm
Nominal, Bare Table (2)	2,100 Hz	2,100 Hz	2,100 Hz	2,100 Hz	1,800 Hz
Max. Static Payload	500 kg	500 kg	600 kg	600 kg	1,200 kg
Natural Frequency (Thrust Axis)	< 5 Hz	< 5 Hz	< 5 Hz	< 5 Hz	< 5 Hz
Stray Flux Density (3)	Less than 10 gauss	Less than 10 gauss	Less than 10 gauss	Less than 10 gauss	Less than 10 gauss
Dimensions (Uncrated) (L x W x H)	1336 x 865 x 1150 mm	1336 x 865 x 1150 mm	1590 x 1395 x 1485 mm	1590 x 1395 x 1485 mm	1605 x 1124 x 1342 mm
Weight (Uncrated)	2,400 kg	2,400 kg	4,700 kg	4,700 kg	10,000 kg
<b>AMPLIFIER UNIT</b>	<b>IPA120H</b>	<b>IPA180H</b>	<b>IPA240H</b>	<b>IPA300H</b>	<b>IPA360H</b>
Amplifier Output	120 kVA	180 kVA	240 kVA	300 kVA	360 kVA
Total Harmonic Distortion (At Rated Output)	From 5 Hz to 2,500 Hz less than 1.2%; from 2,500 Hz to 3,500 Hz less than 1.5% with resistive load				
Signal-Noise-Ratio	More than 70dB at 320V rms output, 10KΩ input termination with rated resistive load		More than 70 dB at 320 V rms output, 10 kΩ input termination with rated resistive load		
DC Stability	Less than 0.05% of full output voltage with 10% change in line voltage				
Input Drive	2 V rms into 10KΩ for full output (320 V rms)				
Amplifier Frequency Response (4)	From 5 Hz to 10 Hz: ±6 dB; from 10 Hz to 5,000 Hz: ±3 dB				
Switching Frequency	150 kHz	150 kHz	150 kHz	150 kHz	150 kHz
Max. Output Voltage	320 V rms	320 V rms	320 V rms	320 V rms	320 V rms
Max. Output Current Per Module (Continuous/ Transient)	190 A rms / 570 A rms	190 A rms / 570 A rms	190 A rms / 570 A rms	190 A rms / 570 A rms	190 A rms / 570 A rms
Amplifier Efficiency	> 90%	> 90%	> 90%	> 90%	> 90%
Dimensions (Uncrated) (L x W x H)	800 x 550 x 2070 mm	800 x 550 x 2070 mm	800 x 1100 x 2070 mm	800 x 1650 x 2070 mm	800 x 1650 x 2070 mm
Weight (Uncrated)	550 kg	600 kg	1,400 kg	1,500 kg	1,800 kg
<b>BLOWING UNIT</b>	<b>HP-4B</b>	<b>HP-4B</b>	<b>HP-4B</b>	<b>HP-4B</b>	<b>HP-4B</b>
Power Output	22 kW	22 kW	22 kW	22 kW	22 kW
Air Flow	1.67 m <sup>3</sup> /s	1.67 m <sup>3</sup> /s	1.67 m <sup>3</sup> /s	1.67 m <sup>3</sup> /s	1.67 m <sup>3</sup> /s
Air Pressure	0.12 kgf / cm <sup>2</sup>	0.12 kgf / cm <sup>2</sup>	0.12 kgf / cm <sup>2</sup>	0.12 kgf / cm <sup>2</sup>	0.12 kgf / cm <sup>2</sup>
Dimension (Uncrated) (L x W x H)	962 x 1329 x 2230 mm	962 x 1329 x 2230 mm	962 x 1329 x 2230 mm	962 x 1329 x 2230 mm	962 x 1329 x 2230 mm
Weight (Uncrated)	420 kg	420 kg	420 kg	420 kg	420 kg
<b>COOLING UNIT</b>	<b>NA</b>	<b>NA</b>	<b>CU-1</b>	<b>CU-1</b>	<b>CU-2</b>
Power Requirement	-	-	8 kW	8 kW	10 kW
Facility Cooling Water Flow	-	-	180 L/min	180 L/min	280 L/min
Facility Cooling Water Pressure Drop	-	-	0.25 ~ 0.4 MPa	0.25 ~ 0.4 MPa	0.25 ~ 0.4 MPa
Dimension (Uncrated) (L x W x H)	-	-	1180 x 1780 x 1850 mm	1180 x 1780 x 1850 mm	1180 x 1780 x 1850 mm
Weight (Uncrated)	-	-	630 kg	630 kg	750 kg

# I SERIES

Specifications are correct at the time of publication. In keeping with our commitment to continuous product improvement, the information herewith is subject to change. ETS reserves the rights to amend specifications without prior notice.

**REMARKS:**

1. Test payload should be less than 10% of shaker weight. Shock Displacement: 63.5mm (High Field); 76mm (Low Field). Continuous Displacement: 41mm (High Field); 51mm (Low Field).
2. First resonance frequency at  $\pm 5\%$  tolerance
3. Measured at 152mm above armature table. Contact us for lower gauss level requirement.
4. Sine mode, resistive load

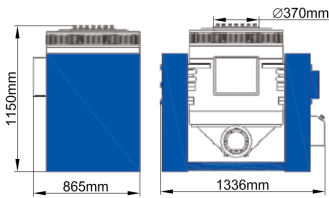

I537M

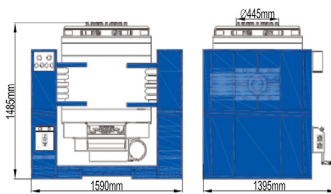

I1045M

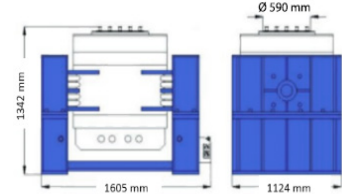

I1859M



IPA Series Amplifier

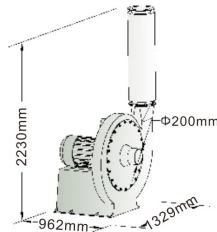

HP-4B

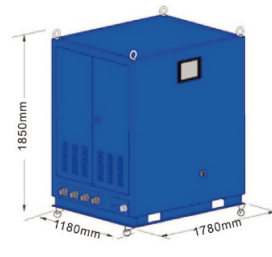

CU-1 CU-2

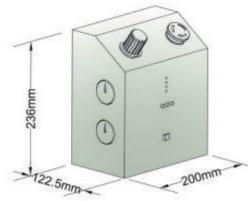

Servo Control Console  
(SCC-1 Unit)



Remote Control Panel  
(RCP)

SYSTEM OPTIONS	IPA120H/I537M	IPA180H/I537M	IPA240/I1045M	IPA300H/I1045M	IPA360H/I1859A
Table Inserts					
M10	●	●	○	○	○
M12	○	○	●	●	●
1/2" UNC	○	○	○	○	○
3/8" UNC	○	○	○	○	○
Internal Load Support	●	●	●	●	●
Thermal Barrier	○	○	○	○	○
Unibase Slip Table	○	○	○	○	○
Air Caster	○	○	○	○	○
Degauss Coil	●	●	○	○	○
Electrical Rotation Unit	○	○	○	○	○
Air Isolation Trunnion	●	●	●	●	●
Geared Aided Rotation (Ratchet Crank)	●	●	○	○	○
Geared Aided Rotation (Chain Wheel Reducer)	○	○	○	●	●
Servo Control Console (SCC-1 Unit)	●	●	●	●	●
Remote Control Panel (RCP)	○	○	○	○	○

● Standard ○ Optional

OPERATING ENVIRONMENTAL DATA	IPA120H/I537M	IPA180H/I537M	IPA240/I1045M	IPA300H/I1045M	IPA360H/I1859A
Max. Heat Rejection to Air (Shaker)	2.76 kW	2.76 kW	7.9 kW	7.9 kW	11.8 kW
Max. Heat Rejection to Air (Amplifier)	9.8 kW	9.8 kW	10.3 kW	10.3 kW	12.2 kW
Max. Heat Rejection to Air (Blower)	12.75 kW	12.75 kW	12.75 kW	12.75 kW	12.75 kW
Max. Heat Rejection to Air (Cooling Unit)	-	-	2.6 kW	2.6 kW	5.1 kW
Working Ambient Temperature *	5 ~ 35 °C	5 ~ 35 °C	5 ~ 35 °C	5 ~ 35 °C	5 ~ 35 °C
Working Ambient Pressure	0.1 MPa	0.1 MPa	0.1 MPa	0.1 MPa	0.1 MPa
Relative Humidity (Non-Condensing)	≤ 80%	≤ 80%	≤ 80%	≤ 80%	≤ 80%
Max. Acoustic Noise	92 dB	92 dB	92 dB	92 dB	92 dB
Max. Temperature of Facility Cooling Water Inlet	0 ~ 35 °C	0 ~ 35 °C	27 °C	27 °C	27 °C
Air Line Supply Required (Compressed Air Supply)	6.9 bar	6.9 bar	6.9 bar	6.9 bar	6.9 bar
Input Voltage (Standard)	380 VAC, 50 Hz, 3 Phase				
Power Requirements	142 kVA	172 kVA	270 kVA	330 kVA	390 kVA

\*Full power to 35 °C, derate at 2% per °C to 50 °C

# MET SERIES

## Vibration System Force Rating from 300 kgf to 10,000 kgf

Ideal for Real World Vibration Simulation and Screening Tests.

ETS Solutions "MET" (Multi-Excitation Testing) Series vibration testing systems can achieve 3-Axis vibration tests simultaneously and is designed to meet the test requirements of wide frequency range, long stroke and high acceleration sine/random/shock test.

An object (or specimen, samples) in the actual vibration environment subject to vibration excitation should be multi-directional, which means that vibration environment is actually a complex multi-degree of freedom vibration environment. As a result of limitations from vibration test equipment in the past, it has to rely on a single direction of vibration test (single-axis vibration testing) in the laboratory to simulate on-site vibration environment.

The "MET" Series Multi-Axis vibration testing system consists of 3 single axis vibration test system specially engineered to function as one system. The "MET" Series system redefines how standard tests can be carried out.

The "MET" Series multi-axis simultaneous vibration test system is a new generation of environmental testing equipment in the space, aviation, weapons, electronics, communications, automotive, home appliances and other industries.



### FEATURES

- Simultaneous dual-axis, tri-axis or multi degree of freedom vibration testing
- Configurable force rating per test axis - configured the desired test axis force rating to achieve the vibration magnitude to meet different testing requirements
- Combined Temperature & Humidity Test Option available
- Compatible with any reputable MDOF vibration controller
- Mixed Mode Vibration test can be achieved to simulate real world environmental conditions
- Test frequency up to 2,000 Hz
- Reduce Test Setup Time and undue Stress to Test Specimen - one time test setup for all axis test
- Air Cooled Design with simple maintenance

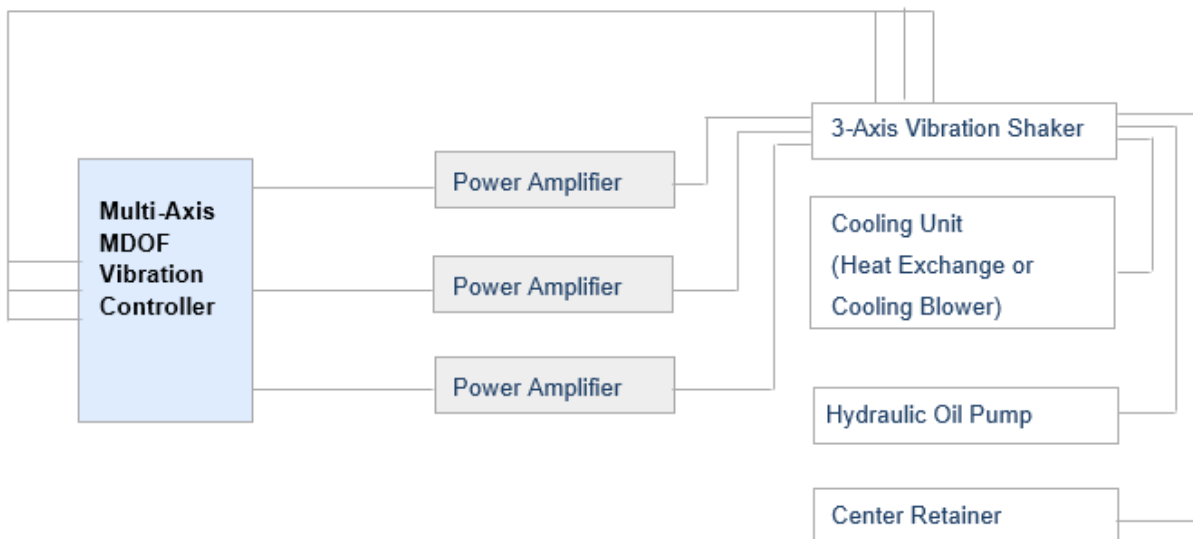



<b>SPECIFICATIONS - MET SERIES</b>						
<b>SYSTEM MODEL</b>	<b>MET-600</b>	<b>MET-2000</b>	<b>MET-4000</b>	<b>MET-5000</b>	<b>MET-7000</b>	<b>MET-10000</b>
Frequency Range	5 - 2,000 Hz	5 - 800 Hz (Sine Full Force) / 5 - 2000 Hz (Random)				
Sine Force	600 kgf	2,000 kgf	4,000 kgf	5,000 kgf (X, Y, Z Axis)	7,000 kgf	10,000 kgf
Random Force	420 kgf	1,400 kgf	2,800 kgf	3,500 kgf (X, Y, Z Axis)	4,900 kgf	7,000 kgf
Max. Displacement (1)	30 mm	30 mm	30 mm	30 mm	30 mm	30 mm
Max. Velocity	1 m/s	1 m/s	1 m/s	1 m/s	1 m/s	1 m/s
Working Table	300 x 300 mm 600 x 600 mm 800 x 800 mm	1000 x 1000 mm	400 x 400 mm 800 x 800 mm 1200 x 1200 mm	600 x 600 mm	500 x 500 mm 1000 x 1000 mm 1500 x 1500 mm	800 x 800 mm 1200 x 1200 mm 2000 x 2000 mm
<b>AMPLIFIER UNIT</b>	<b>MPA102</b>	<b>IPA30L</b>	<b>IPA60L</b>	<b>IPA90L</b>	<b>IPA90L</b>	<b>IPA150L</b>
Amplifier Output	3 x 6 kVA	3 x 30 kVA	3 x 60 kVA	3 x 90 kVA	3 x 90 kVA	3 x 150 kVA
Total Harmonic Distortion (At Rated Output)	From DC (0.1Hz) to 500Hz less than 0.5%; From 500Hz to 5,000Hz less than 1.0%	From 5 Hz to 2,500 Hz less than 1.2%; from 2,500 Hz to 3,500 Hz less than 1.5% with resistive load				
Signal-Noise-Ratio	More than 65dB at 100V rms output, 10K $\Omega$ input termination with rated resistive load	More than 65 dB at 120 V rms output, 10 k $\Omega$ input termination with rated resistive load				
DC Stability	Less than 0.05% of full output voltage with 10% changes in line voltage					
Input Drive	4V rms into 10K $\Omega$ for full output (120V rms)	2 V rms into 10K $\Omega$ for full output (120V rms)				
Amplifier Frequency Response (2)	From DC (0.1Hz) to 4,500Hz: $\pm$ 3dB; From 10Hz to 3,000Hz: $\pm$ 1dB	From 5 Hz to 10 Hz: $\pm$ 6 dB; from 10 Hz to 5,000 Hz: $\pm$ 3 dB				
Switching Frequency	112 kHz	150 kHz	150 kHz	150 kHz	150 kHz	150 kHz
Max. Output Voltage	120V rms	120V rms	120V rms	120V rms	120V rms	120V rms
Max. Output Current per module (Continuous/Transient)	50A rms / 150A rms	250A rms / 750A rms	250A rms / 750A rms	250A rms / 750A rms	250A rms / 750A rms	250A rms / 750A rms
Amplifier Efficiency	> 90%	> 90%	> 90%	> 90%	> 90%	> 90%
Dimensions (Est.) (Uncrated) (L x W x H)	550 x 680 x 1455 mm	550 x 800 x 1850 mm	550 x 800 x 2070 mm	550 x 800 x 2070 mm	550 x 800 x 2070 mm	1650 x 800 x 2070 mm
Weight (Est.) (Uncrated)	280 kg	480 kg	515 kg	550 kg	550 kg	1,950 kg
<b>BLOWER UNIT</b>	<b>HP-2A</b>	<b>HP-3A</b>	<b>HP-3A</b>	<b>HP-4A</b>	<b>HP-4A</b>	<b>NA</b>
Power Requirement	3 x 4 kW	3 x 7.5 kW	3 x 7.5 kW	3 x 22 kW	3 x 22 kW	-
Air Flow	0.21 m <sup>3</sup> / s	0.73 m <sup>3</sup> / s	0.73 m <sup>3</sup> / s	1.035 m <sup>3</sup> / s	1.035 m <sup>3</sup> / s	-
Air Pressure	0.06 kgf / cm <sup>2</sup>	0.082 kgf / cm <sup>2</sup>	0.082 kgf / cm <sup>2</sup>	0.095 kgf / cm <sup>2</sup>	0.095 kgf / cm <sup>2</sup>	-
Dimensions (Est.) (Uncrated) (L x W x H)	748 x 604 x 1450 mm	945 x 693 x 1466 mm	945 x 693 x 1466 mm	1143 x 930 x 2185 mm	1143 x 930 x 2185 mm	-
Weight (Est.) (Uncrated)	115 kg	175 kg	175 kg	370 kg	370 kg	-
<b>COOLING UNIT</b>	<b>NA</b>	<b>NA</b>	<b>NA</b>	<b>NA</b>	<b>NA</b>	<b>CU-1</b>
Power Requirement	-	-	-	-	-	3 x 8 kW
Facility Cooling Water Flow	-	-	-	-	-	180 L/min
Facility Cooling Water Pressure Drop	-	-	-	-	-	0.25 ~ 0.4 MPa
Dimensions (Est.) (Uncrated) (L x W x H)	-	-	-	-	-	1180 x 1780 x 1850 mm
Weight (Est.) (Uncrated)	-	-	-	-	-	630 kg

Specifications are correct at the time of publication. In keeping with our commitment to continuous product improvement, the information herewith is subject to change. ETS reserves the rights to amend specifications without prior notice.

#### REMARKS:

1. Test payload should be less than 10% of shaker weight.
2. Sine mode, resistive load

# MPA SERIES

## Designed for continuous operation with any electro-dynamic shaker

The ETS Solutions MPA Series amplifier family is a wide frequency band digital switching (Class D) Power Amplifier designed with latest state-of-the-art technology. A number of built-in features in the amplifier allow vibration testing to be simple and easy.

The MPA amplifier series are made for continuous operation with each configuration adaptable to any existing or new air-cooled / water cooled electro dynamic shaker. Amplifier outputs range from 1kVA to 300 kVA.



### PERFORMANCE

- High conversion efficiency (greater than 90%) for energy saving
- High modulation switching frequency
- Low total harmonic distortion (< 0.5% at typical testing frequency)
- High signal to noise ratio (> 65%)
- Exceeds ISO Peak current rating of 4-Sigma

### USER INTERFACE

- Intelligence microprocessor logic control and monitoring system
- Interactive system interface
- Green back lit LCD for system status and diagnostic messages
- Auxiliary Interlock Unit (AIU) for additional safety interlock I/O points (Optional)
- Remote control panel via RS485 communication (Optional)

### LOGIC CONTROL UNIT

Managed by high-speed microprocessor logic unit, the intelligence logic control system assures high output power with maximum safety protection. High switching frequency delivers low distortion with full power output over a broad frequency band.

Control logic modulator handles generation of pulse-width modulated driving commands to the power output modules. System digital and analogue feedbacks are optically isolated and processed by the high-speed microprocessor unit. System status and fault indications are real-time displayed on the green back lit LCD panel. Fault occurrences are relayed as interactively on the LCD panel with alarm indication. Solid state relay ensures electrical power control. Power modules operating status are on-line monitored by the control logic modulator. Any over-current, short-circuit or over-temperature situation will prompt an instantaneous system halt.

An optional remote control panel can be connected to the logic module via RS485 communication port. The remote control panel allows full system control at a distance control room of up to 500m.

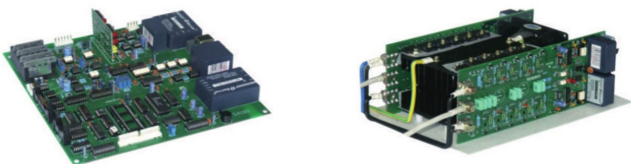

### SAFETY AND RELIABILITY

- Soft-Start and Soft-Stop circuits
- Detailed scope of system interlock protections
- International compliance to safety and EMC standards
- Totally air cooled amplifier designed for continuous and safe thermal operation
- All-encompassing fuse protection for high current system components
- Designed to reduce reliance on mechanical switch gears with CPU logic controlled
- Complies with USA, European and International safety and EMC regulations

### SYSTEM MAINTENANCE

- 12 kVA power modules configured with two self-reliant sub 6 kVA modules
- Interchangeable compact size power modules
- Space saving compact size designs
- Easy maintenance and rapid servicing
- Worldwide spare parts support

### POWER MODULE

Modular and compact sized power output modules are designed with the latest solid state MOSFET technology to ensure optimum performance reliability and overall system efficiency (> 90%). Pulse-width modulated commands from the logic module drive the power modules conversion of DC power rectified from AC line power into variable amplitude and frequency driving power for the shaker. Switching command signals are optically isolated and routed via a ribbon cable. Ample heat sinking and cooling fans are incorporated to allow continuous safe thermal operation. Output driven at rated 120 V rms voltage and 50 A current per module with reserve capacity to provide peak currents of at least 3 times the RMS levels.

Designed to reduce the loss of power during a failed component, the 12 kVA power module is made up of two self-reliant 6 kVA sub modules. Each sub module operates independently in the event when the other is out of action. Built-in operation and fault LED lights provide a quick source to identify the failed sub module.



**SPECIFICATIONS - MPA SERIES POWER AMPLIFIERS**

	<b>MPA100</b>	<b>MPA400</b>	<b>MPA700</b>	<b>MPA3000</b>
Amplifier Max. Power Output	12 kVA	48 kVA	84 kVA	360 kVA
RMS Current Output	100 A rms	500 A rms	700 A rms	3500 A rms
No. of Cabinets	1	1	1	6
Air Flow	200 CFM	300 CFM	450 CFM	600 CFM
Dimensions (L x W x H)	550 x 680 x 1455 mm	550 x 800 x 1850 mm	550 x 800 x 2070 mm	550 x 800 x 2070 mm per bay
Input Drive	4 V rms into 10 k $\Omega$ for full output (120 V rms)			
Input Impedance	10 k $\Omega$ for direct couple single ended connection Output load connections are isolated from ground			
EMC Emissions	In compliance with EN61000-6-2 Emission, EN61000-6-4 Immunity for both conducted and radiated emissions			
DC Stability	Less than 0.05% of full output voltage with 10% change in line voltage			
Total Harmonic Distortion (At Rated Output)	From DC (0.1 Hz) to 500 Hz less than 0.5%; From 500 Hz to 5,000 Hz less than 1.0%			
Switching Frequency	112 kHz			
Signal-Noise-Ratio	More than 65dB at 100 V rms output, 10 k $\Omega$ input termination with rated resistive load			
Amplifier Frequency Response	From DC (0.1 Hz) to 4,500 Hz: $\pm$ 3dB; From 10 Hz to 3,000 Hz: $\pm$ 1 dB			
Rated Output Voltage	120 V rms			
Max. Output Current Per Module (Continuous/Transient)	50 A rms / 150 A rms			
Amplifier Efficiency	> 90%			
Input Voltage (Standard)	380 VAC, 50 Hz, 3 Phase			

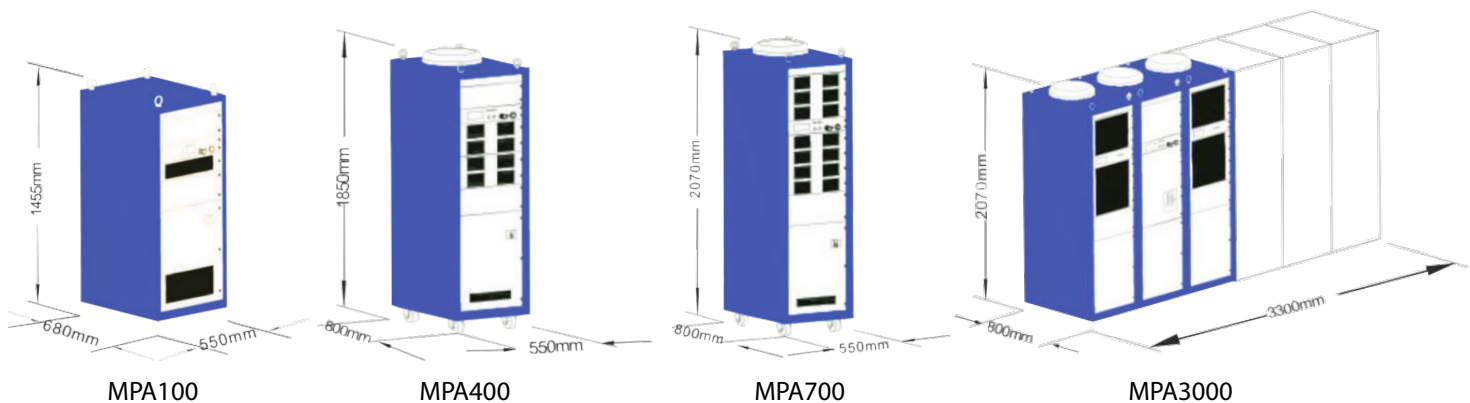
**UPGRADING YOUR OLD AMPLIFIER**

Join the ETS Solutions Replacement Amplifier program. Many customers have benefited by replacing old technologies with our latest amplifier designs. Old shakers systems are revived and the equipment useful life is extended.

Cost savings result from a reduction in:

- Investment for new system
- Service and maintenance fees
- Energy cost
- Equipment downtime

By upgrading from older inefficient amplifiers to the new IPA Series Power Amplifiers, operators can gain from the other benefits that the latest technology can offer. User friendly operations and interactive interface with the intelligence microprocessor control system.

The IPA Series amplifiers operates at over 90% efficiency. Other benefits can include space savings as the amplifiers are smaller in size, heat loss into the test area, all air cooled so no water cooling circuits required. The biggest savings are in power consumption and the associated cost from this. Electricity bills can be dramatically reduced on larger systems by operating at these higher efficiency levels.



Field Supply in Eco Mode - Optional

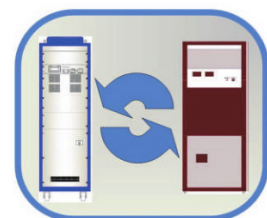

# IPA SERIES

The IPA Series is an 4th generation high performance PWM switching (Class-D) power amplifier designed for continuous operation with any shaker system in the vibration testing industry. The IPA (Intelligent Power Amplifier) series amplifier have incorporated many new features and designs. The IPA amplifier uses a large touch screen user interface and the latest FPGA with DSP technology which is designed to drive and monitor its IGBT power modules output. A complete new design concept is taken to built-in a dedicated FPGA-PWM controller into each power module. The high-speed FPGA-PWM controller handles a closed loop digital signal processed pulse width modulation driving circuit to the IGBT FETs. An error control logic in the FPGA-PWM controller handles low output distortion with fast over-current and short-circuit protection on the IGBT FETs. The FPGD-PWM controller incorporates a synchronous phase logic control to ensure all power modules operates in phase and its output current are balanced. The touchscreen control provides clear and easy interface on the amplifier control and monitoring. It is also capable of remote control and monitoring function via the internet. This makes the IPA series amplifier the most user friendly, reliable and high performance switching amplifier for shaker system in the market. The amplifier outputs range from 30 kVA to 1,200 kVA.



## PERFORMANCE

- New design with High Speed IGBT technology
- Compact sized power module with large output (60 kVA each)
- High conversion efficiency (greater than 90%) for energy saving
- High modulation switching frequency (150 kHz)
- High signal to noise ratio (greater than 70 dB)
- Parallel power module operating output current differential current less than 2%
- Dynamic fault current error control protection
- Intelligent PLC control and monitoring system
- Interactive diagnostic "System Status" on touch screen
- Complete digital control (digital gain and monitoring)

## LOGIC CONTROL UNIT

- Interactive Touch Screen interface
- Fully digital gain with precise sensitivity (1%)
- Multiple languages to choose
- Various extension functions available
- Internet port available for data exchange and remote monitoring

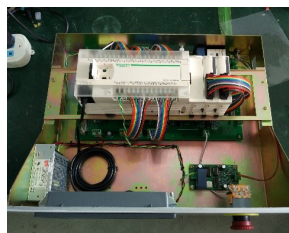
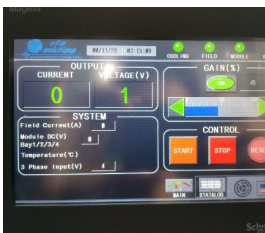

## SAFETY AND RELIABILITY

- Soft start and soft stop circuits
- Detailed scope of system interlock protections
- Totally air cooled amplifier designed for continuous and safe thermal operation
- All-encompassing fuse protection for high current system components
- Interchangeable compact size designs
- Easy maintenance and rapid servicing
- Internet port available for data exchange between amplifier and other equipment
- Remote control and monitoring available via internet port
- Compatible with all vibration controllers
- Worldwide service spare parts support

## POWER MODULE

- DSP/FPGA fully digital PWM control and current protection
- High current output capacity per module
- Constant current output and dynamics current sharing capability
- Ultra fast PWM logic control for high reliable performance
- Robust design to protect the fuses and FETs even in the events of transient over-current or short circuit

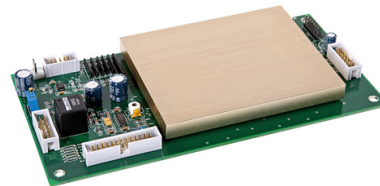

**SPECIFICATIONS - IPA SERIES POWER AMPLIFIER**

	<b>IPA***H</b>
Amplifier Output	60 ~ 1,200 kVA
AC Output Each Power Module	60 kVA
Rated Output Voltage	320 V rms
Rated Output Current Per Module (Continuous/Transient)	190 A rms / 570 A rms
Power Module DC Supply	530 V
Switching Frequency	150 kHz
Signal-Noise-Ratio	More than 70 dB at 320 V rms output, 10 kΩ input termination with rated resistive load
Power Module Current Sharing Differential	≤ 2%
Crest Factor Of Output Current	≥ 3
Input Sensitivity	2 V rms into 10 kΩ for full output (320 V rms)
DC Stability	Less than 0.05% of full output voltages with 10% change in line voltage
Total Harmonic Distortion (At Rated Output)	From 5 Hz to 2,500 Hz less than 1.2%; From 2,500 Hz to 3,500 Hz less than 1.5% with resistive load
Amplifier Frequency Response (Sine Mode, Resistive Load)	From 5 Hz to 10 Hz: ± 6dB; From 10 Hz to 5,000 Hz: ± 3dB
Amplifier Efficiency	> 90%

**SPECIFICATIONS - IPA SERIES POWER AMPLIFIER**

	<b>IPA***L</b>
Amplifier Output	30 ~ 480 kVA
AC Output Each Power Module	30 kVA
Rated Output Voltage	120 V rms
Rated Output Current Per Module (Continuous/Transient)	250 A rms / 750 A rms
Power Module DC Supply	180 V
Switching Frequency	150 kHz
Signal-Noise-Ratio	More than 65 dB at 120 V rms output, 10 kΩ input termination with rated resistive load
Power Module Current Sharing Differential	≤ 2%
Crest Factor Of Output Current	≥ 3
Input Sensitivity	2 V rms into 10 kΩ for full output (120 V rms)
DC Stability	Less than 0.05% of full output voltages with 10% change in line voltage
Total Harmonic Distortion (At Rated Output)	From 5 Hz to 2,500 Hz less than 1.2%; From 2,500 Hz to 3,500 Hz less than 1.5% with resistive load
Amplifier Frequency Response (Sine Mode, Resistive Load)	From 5 Hz to 10 Hz: ± 6dB; From 10 Hz to 5,000 Hz: ± 3dB
Amplifier Efficiency	> 90%



# SLIP TABLE

ETS Solutions offers options of unibase or standalone slip table to meet different requirements for horizontal test.

The unibase is built-in with the vertical shaker body by common steel base platform. The standalone slip table is customized design with an independent steel base platform to match with any new or existing shaker.

## UNIBASE SLIP TABLE

The unibase design is optimized solution for horizontal vibration testing. The common base reinforces assembly allow easy and consistent alignment between shaker and the slip table. The low profile concept conveniently fit for environmental testing with chamber.

## STANDALONE SLIP TABLE

The standalone design, an independent steel platform supported by the levelling feet. The customized design allows the feasibility of any vertical shaker from ETS or other manufacturers to couple with the standalone slip table assembly.

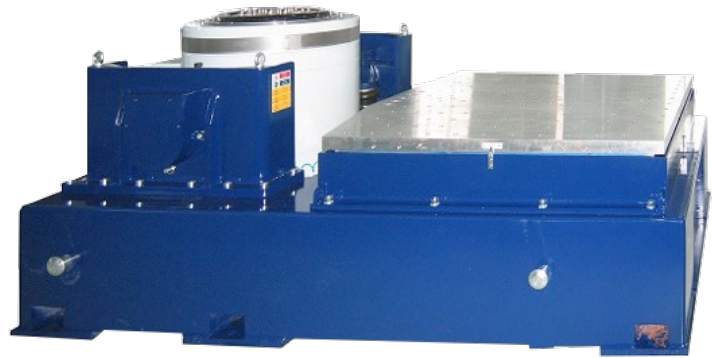

## FEATURES

- Light weight magnesium slip table
- Economical aluminium slip table available
- Low profile reaction mass with total system isolation (less than 5Hz)
- Stiffened and welded steel body design with high mass to force ratios
- Designed for combined environment applications
- Standalone slip table available to interface to any shaker (existing or new)

ETS Solutions slip table are designed to provide the optimum test platform for horizontal testing with any shaker combination.

Our unibase concept provides structural steel body to align the shaker and table on a rigid platform.

All the slip tables are designed with precise grinded natural granite slab with a selection of guidance bearings to meet different application and budgets. The stiffened and welded body provides good reaction mass and damping. The isolation system reduces vibration transmission to the floor and prevents any interference between lab equipment.

Rotation of shaker body to couple the slip table can be performed quickly and easily by one person using the rotation system. Slip plate alignment with shaker is always ensured with mechanical stops installed.

Slip plates can be provided in almost any size from 300mm square (for small shakers) to 2m square for large sized specimen test. Different types of restraining bearings are available to meet different application requirements and operating budgets.

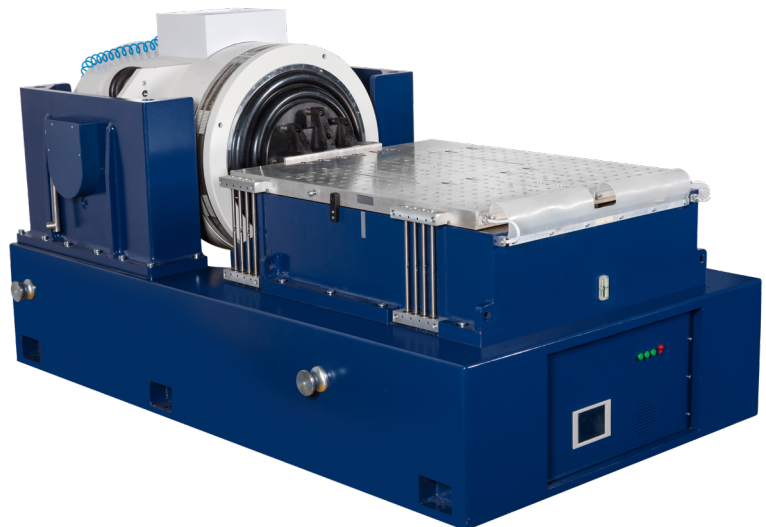

## GT SERIES

GT Series, guided oil film table are designed with less expensive guided V-Groove bearings, combined with magnesium slip table. Oil is supplied through the granite slab port holes and is dispersed throughout the underside of the slip plate. The oil film provides a low friction slip surface and a damping medium for restraint of pitch, roll and yaw moments.

- Magnesium slip plate
- Low pressure hydraulic pump
- Self-contained oil reservoir with oil filter
- Yaw restraint by V-Groove guide bearings combining with the armature guidance system
- Less expensive technique to perform horizontal testing

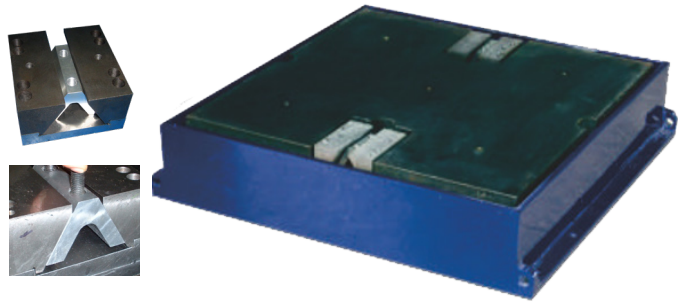

### SPECIFICATIONS - GT SERIES

Slip Table Model	Working Area (mm x mm)	Thickness (mm)	Usable Frequency (Hz)	Slip Plate Mass (kg)	Max. Payload (kg)	Bearing Qty.	Mass per Bearing (kg)	Over Turning Moment (Nm)		
								Pitch	Roll	Yaw
GT300M	300 x 300	25	2000	6	300	1	0.58	1036	1036	203
GT400M	400 x 400	25	2000	9	300	1	0.58	1295	1295	203
GT500M	500 x 500	40	2000	22	400	1	0.58	2529	2529	203
GT600M	600 x 600	40	2000	31	550	1	0.58	4370	4370	203
GT700M	700 x 700	40	2000	41	800	2	0.58	8536	8536	203
GT800M	800 x 800	40	2000	52	900	2	0.58	11642	11642	203
GT900M	900 x 900	40	2000	65	1100	2	0.58	14749	14749	203
GT1000M	1000 x 1000	50	2000	99	1200	2	0.58	20232	20232	203
GT1100M	1100 x 1100	50	2000	124	1200	2	0.58	27192	27192	203
GT1200M	1200 x 1200	50	2000	141	1200	2	0.58	34961	34961	203

## BT SERIES

The BT Series design provides a high over-turning moment and cross-axial restraint. This concept combines a standard slip table assembly with high pressure 3,000 psi hydrostatic bearings to provide high dynamic moment restraint while preserving the damping characteristics of the guide oil film. This system allows testing of heavy products with high center of gravity by reacting moments through the hydrostatic bearings.

- Heavy products testing with high centers with restraint moments by hydrostatic bearings
- High pressure 3,000 psi Hydraulic power supply
- Hydrostatic journal bearings to restrain high pitch, roll and yaw moments
- Pressure interlocks
- Reservoir oil filter
- T-film bearing (optional)

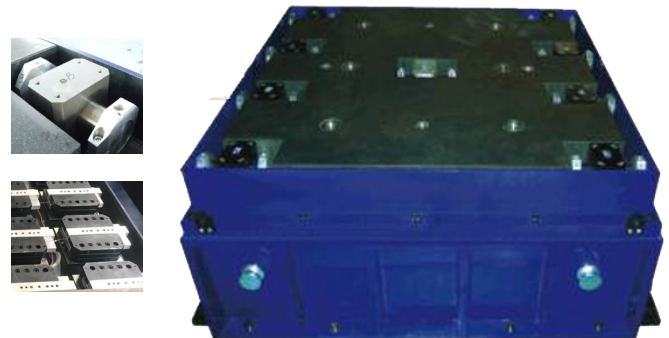

### SPECIFICATIONS - BT SERIES

Slip Table Model	Working Area (mm x mm)	Thickness (mm)	Usable Frequency (Hz)	Slip Plate Mass (kg)	Max. Payload (kg)	Bearing Qty.	Mass per Bearing (kg)	Over Turning Moment (Nm)		
								Pitch	Roll	Yaw
BT700M	700 x 700	50	2000	53	6500	2	4.8	51246	36851	43184
BT800M	800 x 800	50	2000	69	7000	2	4.8	54260	39019	45725
BT900M	900 x 900	50	2000	87	7500	2	4.8	61490	51329	46741
BT1000M	1000 x 1000	50	2000	100	8000	2	4.8	73069	60876	52837
BT1100M	1100 x 1100	50	2000	124	8500	2	4.8	88446	71173	58730
BT1200M	1200 x 1200	50	2000	145	10000	3	4.8	104055	83733	69095
BT1300M	1300 x 1300	50	2000	183	11000	3	4.8	129410	103398	74784
BT1400M	1400 x 1400	50	2000	212	11500	3	4.8	137498	109860	79458
BT1500M	1500 x 1500	50	2000	243	12000	3	4.8	161763	129248	93481
BT1600M	1600 x 1600	50	2000	276	12500	3	4.8	188687	152920	94294
BT1700M	1700 X 1700	60	2000	375	13000	3	4.8	212273	172035	106081
BT1800M	1800 X 1800	60	2000	420	13500	3	4.8	235859	191150	117868

#### Remarks:

1. Slip Table inserts standard grid pattern. Armature inserts pattern plus 100mm x 100mm grid.
2. All the specifications here are for magnesium material. Please contact ETS for aluminium material specifications.

## DOUBLE SLIP TABLE UNIBASE

Double Slip Table Unibase allows users to have double configuration of the slip table in order to perform different tests.

The shaker system can rotate 180 degree in order to be combined with both tables. In the middle position, the shaker can be combined with the Head Expander in order to perform vertical test.

This configuration is suitable for GT Series and BT Series.

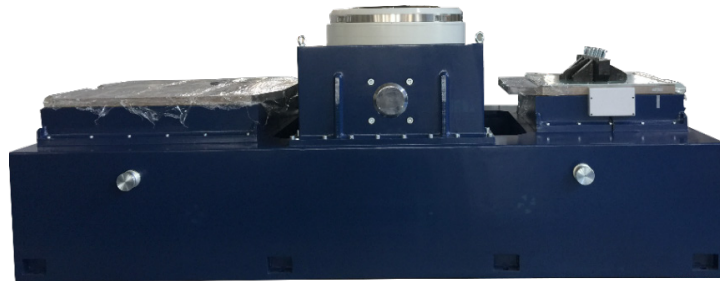
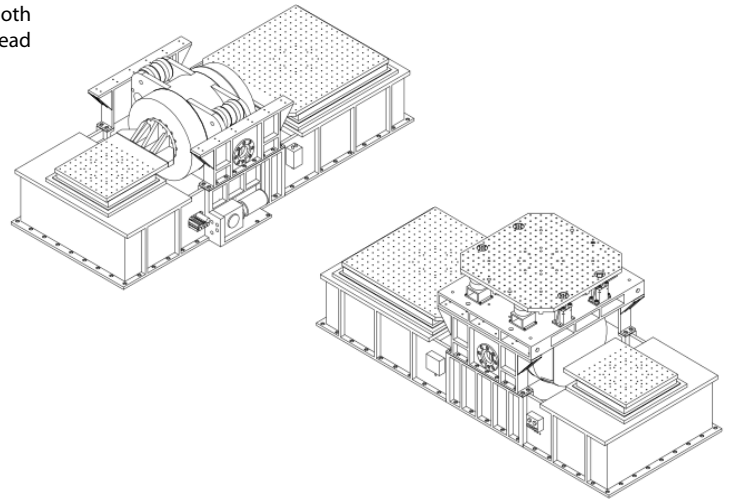

## TABLE IN TABLE UNIBASE

Table in Table Unibase allows users to have double configuration of the slip table in order to perform different tests.

The small and the big table are integrated in order to save space in the lab. In order to perform the test with the small table the user has just to detach it from the bigger table.

Simple configuration and easy to use.

This configuration is suitable for GT Series and BT Series.

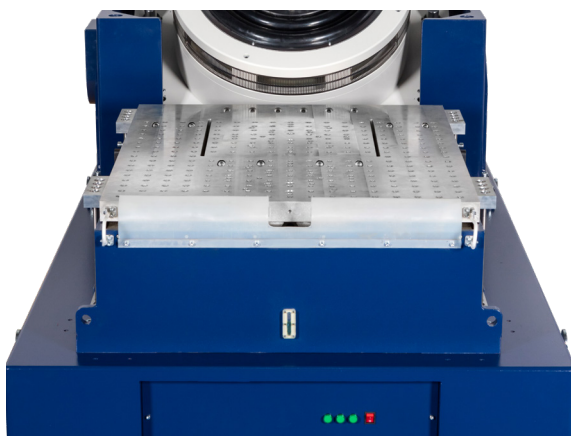
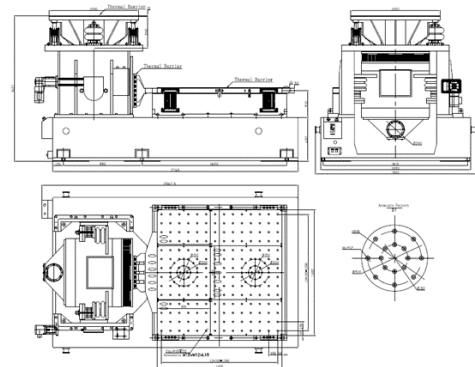



# DRIVER BAR

ETS driver bars provide perfect link between shaker and slip table.

- Magnesium driver bars
- FEM design
- Casting single pieces
- Precision coupling
- Excellent force transmission



DRIVER BAR WEIGHT												
Shaker Model	L215M	L315M	L620M	M124M	M232A	M437A	M544A	M748A	LS232A	LS437A	LS544A	LS748A
Weight	1.4 kg	1.4 kg	2.2 kg	4.6 kg	5.8 kg	8 kg	19.7 kg	19.7 kg	5.8 kg	8 kg	19.7 kg	19.7 kg
Shaker Model	H844A	H1248A	H1859A	H2565A	H3580A	I537M	I1045M	I1859A				
Weight	19.7 kg	19.7 kg	50 kg	80 kg	150 kg	8 kg	19.7 kg	50 kg				

# STANDARD ACCESSORIES

### Geared Aided Rotation

Rotation of the shaker body to work with the slip table is achieved by either ratchet crank rotation chain wheel gear reducer. Rotating of the shaker is perform with ease by rotation aid. Mechanical stop is installed to align the shaker with table precisely.



### Safety Protection

The Stainless steel guard is installed in front of slip plate. The safety protection prevents any operators from putting their fingers into the oil trough. It will prevent any falling foreign particles or contaminants from falling into the oil trough during the test.



# OPTIONAL ACCESSORIES

### Air Isolations Feet

Optional air isolation feet prevent the vibration from the shaker during operation from transmitting to the floor and building. The need for an seismic base can be eliminated.



### Air Caster

The air caster is the load module system which utilizes the air film to float the shaker system. The load movement is easy, exceptionally smooth and omnidirectional.



### Levelling Feet

The levelling feet is combined with the outrigger support and adjustable foot. The levelling feet could provide efficient precision mounting and swift screw adjustment. This allows consistent and solid support for the heavy assembly.



### Thermal Barriers

Glass fibre thermal insulating sheet is available when the slip table is to be integrated with the chamber for combined vibration-temperature testing.

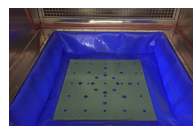

### Electric Rotation Unit

The electric rotation unit enables easier reconfiguration for switching shaker test axis.



### Noise Enclosure

Acoustic enclosure to reduce the noise of the cooling blower in installations where the blower cannot be located outside the working area.



# HEAD EXPANDER

ETS Solutions offers Head Expander for applications where larger vertical test mounting surface are required.

Head Expanders are manufactured from light-weight magnesium alloys, providing high strength to weight ratio. A choice of less expensive aluminium alloys is also available for smaller fixtures without much addition to the total mass.

The Head Expander allows multiple items to be tested at the same time, decreasing total test.

A group of experienced engineers provide a turnkey of head expander solutions by FEM design, accurately calculation, precise machining, special processing makes, flatness and parallelism working surface and insure maximum strength and penetration.

Latest software for precision calculation is incorporated into the fixture designs to produce the best results for designed fixture with an overall dynamic performance.

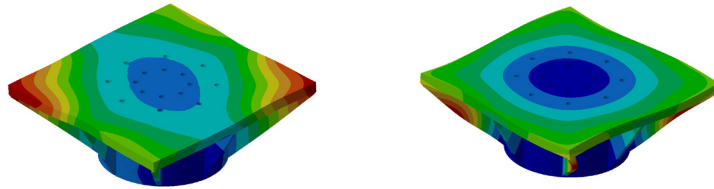

## FEATURES

- Uniform surface obtained by precision machining
- Magnesium composition fixture for lower total operating mass
- FEM designed fixtures for predictable results
- Round, square and octagon shape Head Expander are available
- Useful frequency up to 2,000Hz
- Designed to couple with your current shaker system
- Integrated easily for use with thermal chamber and with optional thermal barrier
- Cost effective to increases production testing yield
- High resonant frequencies available, depending on size
- Choice of insert mounting hole pattern available
- Special surface processing by coating with protect layer could achieve a long time operating

# SPECIAL CUSTOMIZED FIXTURES



3.5 x 3m HE with 16 Ton Load Support and Guidance System



Cube Fixture for Components Testing



Special Dual Shaker Coupling Test Jig



Test Jig for Shaft Coupling

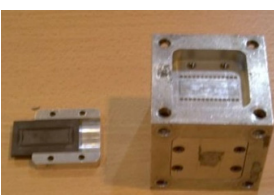

Cube Fixture for Semiconductors



Special Test Jig for Vehicle Alternator Type-2



Test Rig for Satellite Dish



Test Jig for Exhaust Manifold

### SQUARE HEAD EXPANDER SPECIFICATIONS

Table Diameter	150 mm	200 mm	240 mm	320 mm	370 mm	445 mm	480 mm	590 mm
Model								
HE300SQM	6 kg	10 kg						
	2200 Hz	2700 Hz						
HE400SQM	10 kg	16 kg	20 kg		18.5 kg			
	2181 Hz	2500 Hz	1238 Hz		2000 Hz			
HE500SQM	21 kg	25 kg	21 kg	25 kg	26 kg	15 kg		
	1869 Hz	2100 Hz	2107 Hz	1700 Hz	1810 Hz	1550 Hz		
HE600SQM	30 kg	35 kg	35 kg	40 kg	40 kg	60 kg		
	1625 Hz	1649 Hz	1564 Hz	1639 Hz	1590 Hz	1867 Hz		
HE700SQM			60 kg		55 kg	52 kg		
			1254 Hz		1450 kg	1420 Hz		
HE800SQM			75 kg	90 kg	75 kg	70 kg	70 kg	
			1265 Hz	1300 Hz	1648 Hz	1750 Hz	1153 Hz	
HE900SQM				90 kg	120 kg	130 kg	100 kg	
				1092 Hz	1200 Hz	1650 Hz	1428 Hz	
HE1000SQM				90 kg	130 kg	150 kg	140 kg	160 kg
				853 Hz	937 Hz	1237 Hz	1000 Hz	959 Hz
HE1200SQM						250 kg	240 kg	200 kg
						668 Hz	784 Hz	907 Hz
HE1300SQM				55 kg				
				711 Hz				
HE1400SQM								
HE1500SQM				240 kg	210 kg	300 kg	340 kg	500 kg
				400 Hz	431 Hz	373 Hz	605 Hz	769 Hz

### ROUND HEAD EXPANDER SPECIFICATIONS

Table Diameter	150 mm	200 mm	240 mm	320 mm	370 mm	445 mm	480 mm	590 mm
Model								
HE300RDM	7 kg		10 kg					
	2760 Hz		2970 Hz					
HE400RDM		15 kg						
		2500 Hz						
HE500RDM		13 kg	25 kg					
		1644 Hz	2468 Hz					
HE600RDM					35 kg	30 kg	40 kg	
					1890 Hz	1936 Hz	1850 Hz	
HE700RDM			37 kg				36 kg	
			1865 Hz				1750 Hz	
HE800RDM				60 kg		70 kg		
				1200 Hz		1450 Hz		
HE900RDM				65 kg				
				1585 Hz				
HE1000RDM						130 kg		110 kg
						1100 Hz		1650 Hz
HE1200RDM								

The above mentioned effective mass and usable frequency are for the magnesium alloy head expander. Specification are indicative only and subject to change. For the aluminium alloy head expander specification or customizable dimensions, please contact us.

HE300SQM means it is square head expander, the effective size of the head expander is 300 x 300 mm, Magnesium.

HE300RDM means it is round head expander, the diameter of the head expander is Ø 300 mm.

HE □□□□ □□□ - □□□



## LOAD SUPPORT SYSTEM

Head Expanders with load support guidance allows payloads with large foot prints to be safely mounted and tested on the shaker, reducing the risk of damage to the shaker suspension system.

The Guided Head Expanders are designed for testing of large, heavy packages to handle tough transportation and other demanding test profiles while providing additional restraints and load support.

The load support system has different options to maintain different testing requirements. An ideal testing result achieved by optimized design, latest software analysis, and perfect machine.



## BEARING GUIDANCE

Provide good constraints for cross-axial, rotation and overturning. Utilize linear bearings and number of shear mountings, which is optimized for high center-of-gravity and off-set load.

- High frequency
- Stable and safe
- Easy to install and maintain
- No damage to the system suspension system

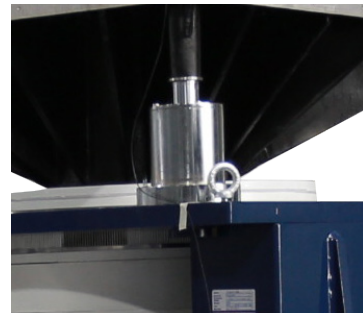

## LOAD ISOLATION SUPPORT

Pneumatic isolation support is supported by the air bags and bearings. Its low frequency applied option.

- Economical cost
- Reasonable isolator array
- Restraint rotation and overturning
- Easy to be installed and aligned



## THERMAL BARRIER

G10 insulating sheet provides bolts pattern on the surface. Could be rigidly installed onto slip table for horizontal operation with chamber.

HE900RDM-480 with Thermal Barrier & Load Support for 2 Ton Payload

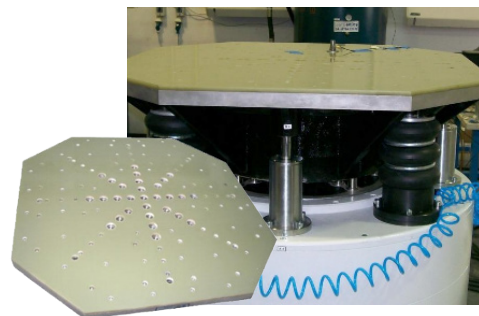





## GUIDED LIFTING SYSTEM

Guided head expander fitting post for quick axial switch over.



# ACCELEROMETERS

Offered in various models with available sensitivities from 1 mV/g to 1000 mV/g, design features a ceramic or quartz shear sensing element packaged within a laser welded rugged titanium housing, with 10-32 radial connector and 10-32 stud mounting capabilities. Optional Transducer Electronic Data Sheet (TEDS; per IEE 1451.4) capabilities are also available for larger channel count applications. Units are base isolated to avoid EMI/ground loop interference and incorporate low-noise JFET electronics.

	IEPE	Charge	Miniature	Tri-Axial	Shock
					
Features	<ul style="list-style-type: none"> <li>- Single Axis</li> <li>- Lightweight</li> <li>- High Sensitivity</li> <li>- Base Isolated</li> <li>- Radial Connector</li> <li>- Optional TEDS capabilities</li> <li>- IEPE</li> </ul>	<ul style="list-style-type: none"> <li>- Single Axis</li> <li>- Lightweight</li> <li>- High Sensitivity</li> <li>- Base Isolated</li> <li>- Radial Connector</li> <li>- Charge mode</li> <li>- High Temperature</li> </ul>	<ul style="list-style-type: none"> <li>- Miniature Design</li> <li>- Adhesive Mount</li> <li>- Integrale Cable</li> <li>- Ultra Lightweight</li> <li>- Base Isolated</li> <li>- IEPE</li> </ul>	<ul style="list-style-type: none"> <li>- Triaxial</li> <li>- Lightweight</li> <li>- 10-32 Stud Mount</li> <li>- Optional High Temperature</li> <li>- Base Isolated</li> <li>- IEPE</li> </ul>	<ul style="list-style-type: none"> <li>- High Natural Frequency &gt; 100 kHz</li> <li>- Broad Frequency Response</li> <li>- Base Isolated</li> <li>- IEPE</li> </ul>
Application	<ul style="list-style-type: none"> <li>- Routine Vibration Testing</li> <li>- Product Testing</li> <li>- Structural Testing</li> <li>- Vibration Control</li> <li>- Package Drop Testing</li> </ul>	<ul style="list-style-type: none"> <li>- Routine Vibration Testing</li> <li>- Product Testing</li> <li>- Structural Testing</li> <li>- Vibration Control</li> <li>- Package Drop Testing</li> <li>- Agree Chamber Testing</li> </ul>	<ul style="list-style-type: none"> <li>- Drop Testing &amp; Package Testing</li> <li>- Small Components Qualification Testing</li> <li>- Low Amplitude Vibration Measurement</li> <li>- High Frequency Applications</li> <li>- Space Restricted Installations</li> </ul>	<ul style="list-style-type: none"> <li>- Modal Analysis</li> <li>- Micro Machining</li> <li>- Motor &amp; Pumps</li> <li>- Vibration Isolation</li> </ul>	<ul style="list-style-type: none"> <li>- Drop Testing</li> <li>- Far-field Blast Testing</li> <li>- Pyrotechnic Testing</li> <li>- Shock Testing</li> </ul>
Sensitivity (mV/g)	10, 50, 100, 200, 500	0.4, 2.5, 5, 10, 15 pC/g	2, 5, 10	1, 5, 10	0.05, 0.1, 0.25, 0.5, 1, 2
Full Scale Range for +/- 5V output (g's)	500, 100, 50, 25, 10	-	500, 10000, 2500	5000, 1000, 500	70000, 50000, 20000, 10000, 5000, 2500
Frequency Range (Hz)	1 to 10,000 (+/-5%)	1 to 10,000 (+/-10%)	0.7 to 7,000 (+/-10%)	1.5 to 5,000 (+/-15%)	0.35 to 10000 (+/-10%)
Weight (grams)	10	10	0.2	4.0	6.0

# ACCESSORIES



In-Line Charge Amplifiers



Signal Conditioners



Impulse Hammers



IEPE Current Source Power Units

# CABLES

Get connected with our vast offering of cable assemblies. Choose from "standard" 10-32 type, coaxial connectors or ultra-miniature cables with 3-56 threaded plugs. Standard offerings include 10-32 to 10-32 and 10-32 to BNC combinations with regular RG196 or low noise RG196 coaxial cable. Many industries from laboratory to industrial are covered.



# VIBRATION CONTROL

Complete portfolio solution for noise and vibration testing can be offered with the ETS Solutions vibration testing system. We can offer entry-level vibration control system till high-end control system. The control system will combine optimal ease of use with the performance and reliability of an advanced system.

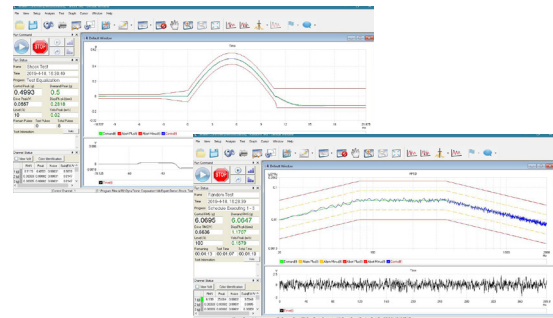
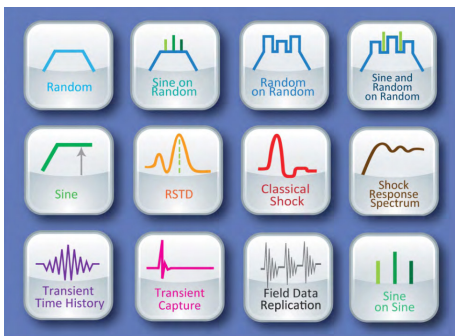

## FEATURES

- Configurable from 2 to 2000+ channels
- Input signal conditioning: Voltage, ICP, charge, strain, tacho \*
- Output conditioning and signal generation
- Autonomous recording on Compact Flash card \*
- On-the-spot validation measured data \*
- Wireless PDA smart control with Bluetooth communication
- On-board GPS and CAN \*
- Parallel data streaming to internal memory & PC \*
- Easy-to-use recorder software for acquisition measurement set-up, instant data validation and data export \*

\* Available only in high end control system

## APPLICATIONS

### Aerospace engineering

- Ground vibration & modal survey testing
- Operational modal analysis
- Dynamic testing & qualification of Jet engines

### Automotive engineering

- Engine noise & vibration testing
- Squeak & Rattle testing
- Sound power testing
- Acoustic intensity testing
- Sound quality
- Pass-by noise testing
- Acoustic material testing
- Modal testing and analysis

### Heavy machinery testing

- Modal testing and analysis

### Wind energy & power generation system testing

- Off-road, construction and agricultural vehicles
- Consumer and business electronics acoustic and vibration testing

## SOFTWARE

### Sine control

- Swept Sine Control
- Tracked Sine Dwell
- Sine Notching
- Throughput Recording
- Online Sine Reduction

### Random Control

- Response Limiting
- SoR, RoR, SoRoR
- Kurtosis
- Online Random & Acoustic Reduction

### Transient

- Shock Control
- Measured Pulse
- SRS, SRA
- Transient Capture

### Advanced

- Test Sequencing
- Analysis: ODS
- Time Animation
- Modal Analysis, Compare runs

The system offers accurate closed-loop shaker control and a maximum of built-in safety mechanisms, which minimize the risks of damaging costly test items. User guidance and secure automation capabilities deliver maximum productivity and enable testing teams to meet critical deadlines.

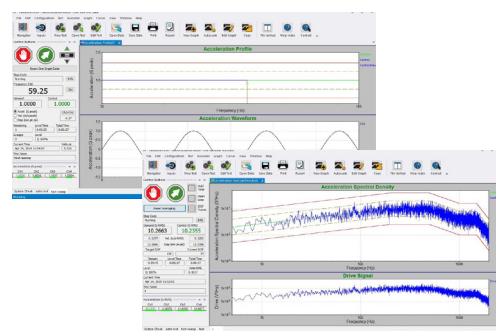
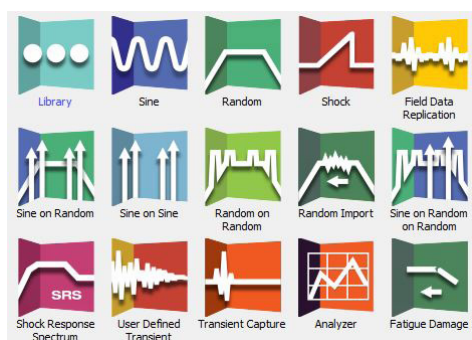

## FEATURES

- User friendly
- Drag and Drop, enables users to quickly load any test into Microsoft® Word or Excel.
- Ethernet connection
- PC and Windows integration
- Customizable reporting, presentation-ready, sophisticated reports at the end of testing sequence
- 128 available inputs, scalable from 1 to 128 channels
- Rack mountable, easily mounted on an amplifier rack, which eliminates the need for long accelerometer and drive cables
- Web and Email option / remote interface
- Easy integration

## HARDWARE FEATURES

- < -100dB THD+N
- Control Sine, Random, or Shock vibration to 50,000Hz
- 26,000 lines of resolution
- 24-bit dynamic range
- > 100dB Random dynamic range
- > 130dB Sine dynamic range
- 1 to 128 simultaneous channels
- Analog anti-aliasing filters
- Digital anti-aliasing filters with < -92dB attenuation
- 24-bit Digital to Analog (DAC) converter
- Analog reconstruction filters

## APPLICATIONS

- Aerospace
- Automotive
- Medical
- Military
- Packaging
- Transportation

## SOFTWARE

- Sine Control
- Accelerometer Calibration Verification
  - Sine Resonance Track and Dwell Control
  - High Frequency for Sine
  - Step Test Mode
  - Sine-on-Sine

- Random Control
- Random-on-Random
  - Sine-on-Random
  - Random Import
  - Sine-and-Random-on-Random
  - High Frequency for Random

- Shock Control
- Shock Transient Capture
  - Shock Response Spectra Control
  - High Frequency for Shock
  - Transient Waveforms Control

- Fatigue Damage Spectrum
- Kurtosis
- Field Data Replication
- Instant Degrees of Freedom

# ENVIRONMENTAL VIBRATION TEST SYSTEM

State-of-the-art climatic chamber for combined vibration, temperature and humidity environmental testing



- Various customized chamber sizes
- For desired shaker and slip table sizes
- Designed for rapid temperature change rates
- Mechanical refrigeration cooling systems
- High performances

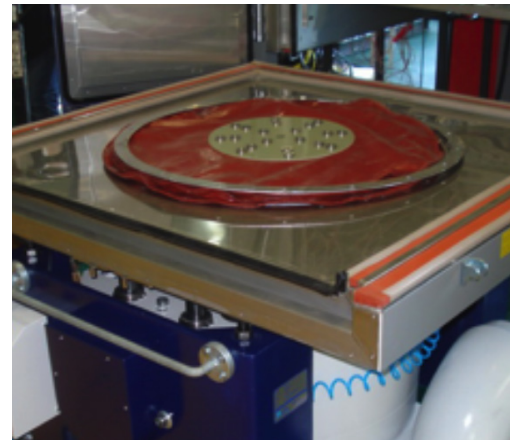
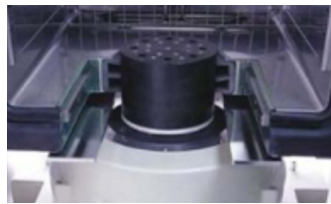

ETS Solutions can supply shakers with a climatic chamber to customer specifications and needs. The system can be movable or non-movable depending on test requirements.

The AGREE chambers have been the workhorses of the environmental test chamber industry.

Originally created to meet military test standards, their flexible design has made them suitable for a wide variety of applications. Fast temperature changes of 5 to 25° C/m are possible, even with significant loads. The chambers have a removable floor, allowing integration with vibration test systems. Custom designs are available, allowing configurations to meet your exact requirements.



**Cabinet**

- Full opening door with multi-panel heated window & interior light
- Chamber floor designed to be changeable to accommodate different "floor plugs" for vibration systems. Standard floor plug provided is "solid" for non-vibration applications (other floor optional). Embedded perimeter heaters in floor plugs to avoid condensation and freeze-up, plus Teflon glides in floor slot make floor replacement very easy
- One 4" cable port with flexible plug centered in the left hand wall (additional ports optional)

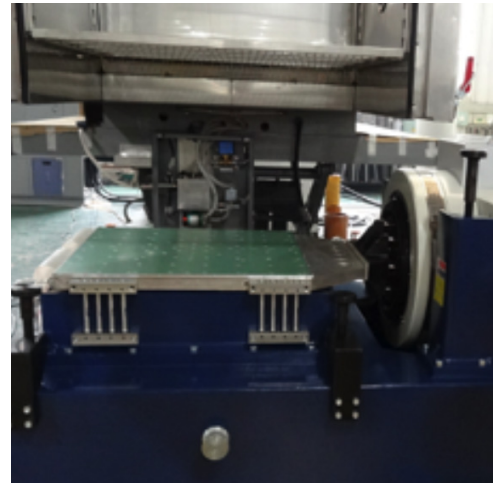

**User friendly interface**

- 7" TFT color LCD Display, optional 5.7" and 10"
- Up to 100 programs can be stored in memory with 100 steps for each program, 9999 max. circles
- RAM with battery protection, equipment setting value, sample value and sample time can be saved, max. record time is 4 years (sample interval is 1 min.), graphic test data display and CSV format test data logging file, real time recording of temperature and humidity versus time
- Power failure protection function, alarm indication function, help function, circuit breaker, upper and lower limit temperature protection function, timer function (automatic start and stop), self-diagnosis function, over-load protection function, over-pressure protection function





The world largest high performance 4 Poster vibration test system with four 350kN vibration test systems, successfully applied to carry out vibration test on mining vehicles.

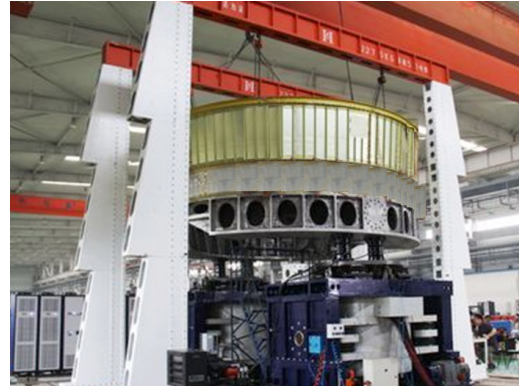

The dual H3580A 350kN system coupled with our customized-design 5m diameter head expander redefine how the industry carry out vibration test on extremely large structures. The 'Combo System' is designed to handle dynamic payload of up to 10ton satellite.

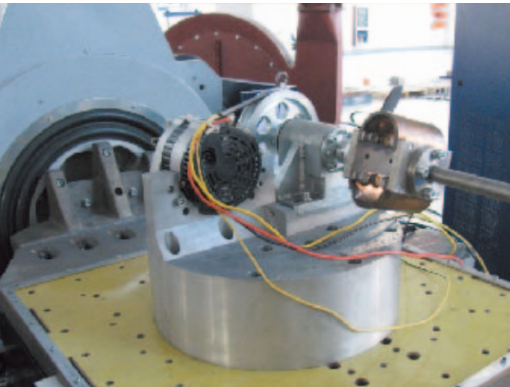

A customized M Series M748A vibration system to carry out product qualification and fatigue test on vehicle alternator that is under simulated field conditions.



Aircraft landing gear suspension dampener fatigue test carry out on a customized LS Series shaker unit with adjustable clamping jig for different DUT length. The system is capable of achieving continuous 90mm peak to peak displacement.

Customized 4.5m slip table combined with two 350 kN vibration test system

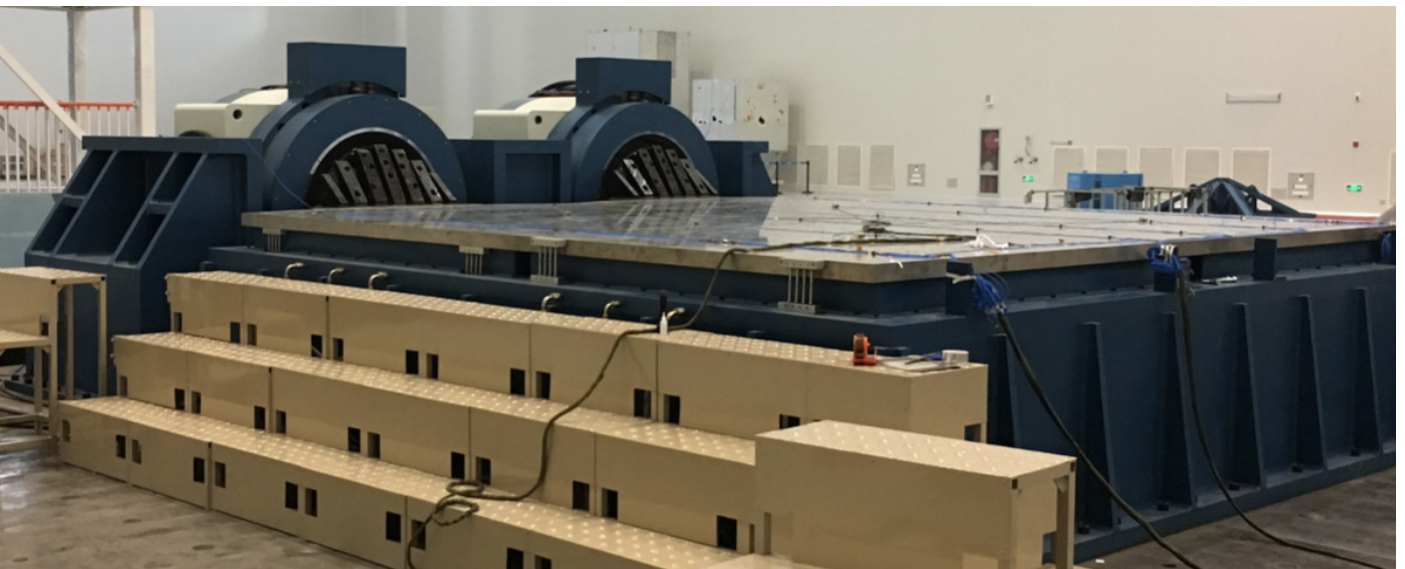



The H3580A 350kN system coupled with our customized design 2.5m head expander and slip table, capable to take up dynamic payload of up to 5 ton.



The H128A (100kN) shaker designed with a customized head expander with load support and guidance for dynamic lateral restraint to test the 2.5 ton turret payload.



Product design reliability testing on an industrial handheld tablet by a M124M shaker with 500 x 500 mm slip table.



High intensity vibration testing on the 250 kgf high speed train traction motor is carried out by the H Series H1859A shaker unit to validate its system performance and conformance to its criteria under abnormal field conditions.

Customized slip table with 350kN vibration testing system





**ETS Solutions Asia Pte Ltd**

No 1 Kaki Bukit Road 1  
Enterprise One #03-20  
Singapore 415934

Tel: +65 6340 1036  
Fax: +65 6340 1037  
Email: [sales@etssolution-asia.com](mailto:sales@etssolution-asia.com)  
Website: [www.etssolution-asia.com](http://www.etssolution-asia.com)

