



Worcester 18/19 Series Modular Multi-Way Ball Valves



Experience In Motion

The Modular Approach To Flexibility

Flowserve Worcester's modular Series 18/19 multi-way valve addresses the need for diverting media through a number of flow paths.

Currently used extensively on a variety of chemical and food processes, the potential applications for this valve are extensive. When compared with a plug valve for example, the Series 18/19 offers numerous advantages, including bubble tight shut-off, long sealing life, extended temperature range, ease of maintenance, material range, no need for sealant etc.

The Series 18/19 is primarily of a firesafe design, complying with BS 5351 and is offered in both full and reduced bore, and with its four seat design, provides straight-through flow capability to minimise pressure drop. This unique valve design is based on a modular principle which offers almost unlimited flow permutations. In addition, the Series 18/19 can be offered as a high integrity valve for toxic media or with a retrofitted steam jacket.

Size Range

The Series 18/19 is available in sizes ranging from 15mm ($\frac{1}{2}$ " to 150mm (6") full bore and 20mm ($\frac{3}{4}$ " to 200mm (8") reduced bore.

Body Style

Series 18 - Side Entry Configuration (B18 = Full Bore, 18 = Reduced Bore) Series 19 - Bottom Entry Configuration (B19 = Full Bore, 19 = Reduced Bore)

Body Porting

The body is designed to allow for a maximum of 5 ports. An example of one such application is where the bottom entry port is used as the inlet, allowing the side entry ports to fill up to four separate tanks.

The design incorporates interchangeable inserts which allow the valve to be easily re-configured to suit customer requirements.

Applications

Applications vary from road tankers, heat exchangers and pulp grinding machines to remote undersea vehicles and ships' ballast systems. The valve can also be used for pig loading, as a compact 90° corner valve and for by-pass operations.

Typical media include chemicals, filtrates, fuel oil, hot water, air, fats, gasoline, chocolate mass, toothpaste, sugar, tobacco and others.

Flow Indication

The valve is designed with a stem assembly incorporating foolproof orientation of ball to stem and stem to indicator, thus providing external indication of ball position to verify correct operating sequence whether manual or actuated.

Pipe Connections

FLANGES

Another example of the modular flexibility of the Series 18/19 is the use of slip flanges which can accommodate ANSI/DIN and other standards up to and including Class 300 pressure rating. Furthermore, during installation, these flanges facilitate alignment of the valve in the pipework.

FACE TO FACE LENGTHS

The screwed insert design allows for most ANSI/DIN face to face lengths, as well as longer non-standard dimensions.

SCREWED AND WELD ENDS*

As a variation on the above, the Series 18/19 can be supplied with either female screwed ends (NPT and BSP variants), socket weld or butt weld ends to suit schedule pipe to BS 1600.

Balls

The parallel-ported ball is available in a variety of flow path configurations, for example 'L' port, 'T' port, double 'L' port or other designs. The problem of cross-contamination on diverter valves can be addressed by using a bottom-entry, three-flanged valve with an L-ported ball operated through 180°.

Seats

A range of seat materials, many of which are manufactured in-house by Worcester Controls, can be supplied to accommodate various media and pressure/temperature conditions.

Materials of Construction

While standard materials of construction are stainless steel or carbon steel, this valve can be manufactured in potentially any available wrought material to allow full compatibility with the pipework/process conditions.

Actuation

The introduction of Norbro's 180° Series 40R pneumatic actuator allows two or three position capability between 0 and 180°. This can also be achieved with Norbro's Series 75 electric actuator. Together with the ISO mounting platform on the valve, this provides for an easily assembled, yet fully integrated multi-way valve system.

*Please note, these are not available in all sizes, for further information on connection configuration, consult Flowserve Worcester Controls.

Application Limitations

Cross Contamination

Due to the compact design of this valve, during its operation all three or four side ports will be open and therefore mixing of media between these ports will occur. Alternative designs are available to suit applications where cross contamination is unacceptable.

Upstream Sealing

There is a limitation to the differential pressure between the communicating ports P1 and the port which is closed to the flow P2 (see diagram) where $P2 > P1$. This differential pressure is based upon the seat material and the operating temperature of the valve. If differential pressures and temperatures in direction P2 exceed the limits of the upstream sealing graphs on page 11, media can pass the closed port and mix with P1. These applications should be referred to Flowserve Worcester Controls.



19 Series shown

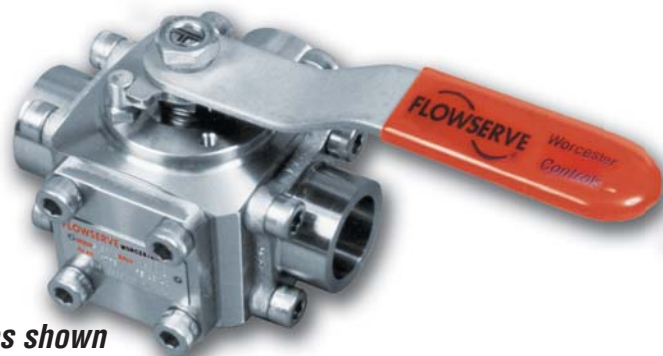
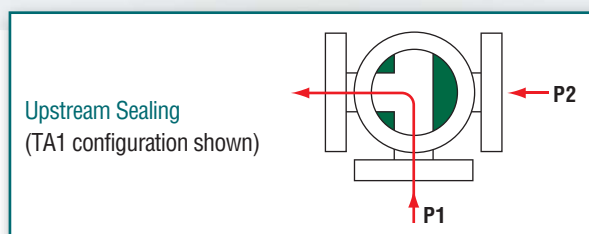

18 Series shown

Features	Benefits
● Foolproof stem assembly to ball	● External indication of flow
● Slip flanges	● To simplify installation
● Compact size	● For space and weight saving
● Ball/port variations	● Maximum flow permutations
● User-interchangeable flange/ends	● To meet different system requirements
● Screwed insert design	● For variable face-to-face lengths
● Range of seat materials	● For varying media/systems conditions
● Wrought body material options	● To optimise system compatibility
● Full bore porting	● Greater flow efficiency
● ISO mounting platform	● For ease of automation

18 / B18 Series

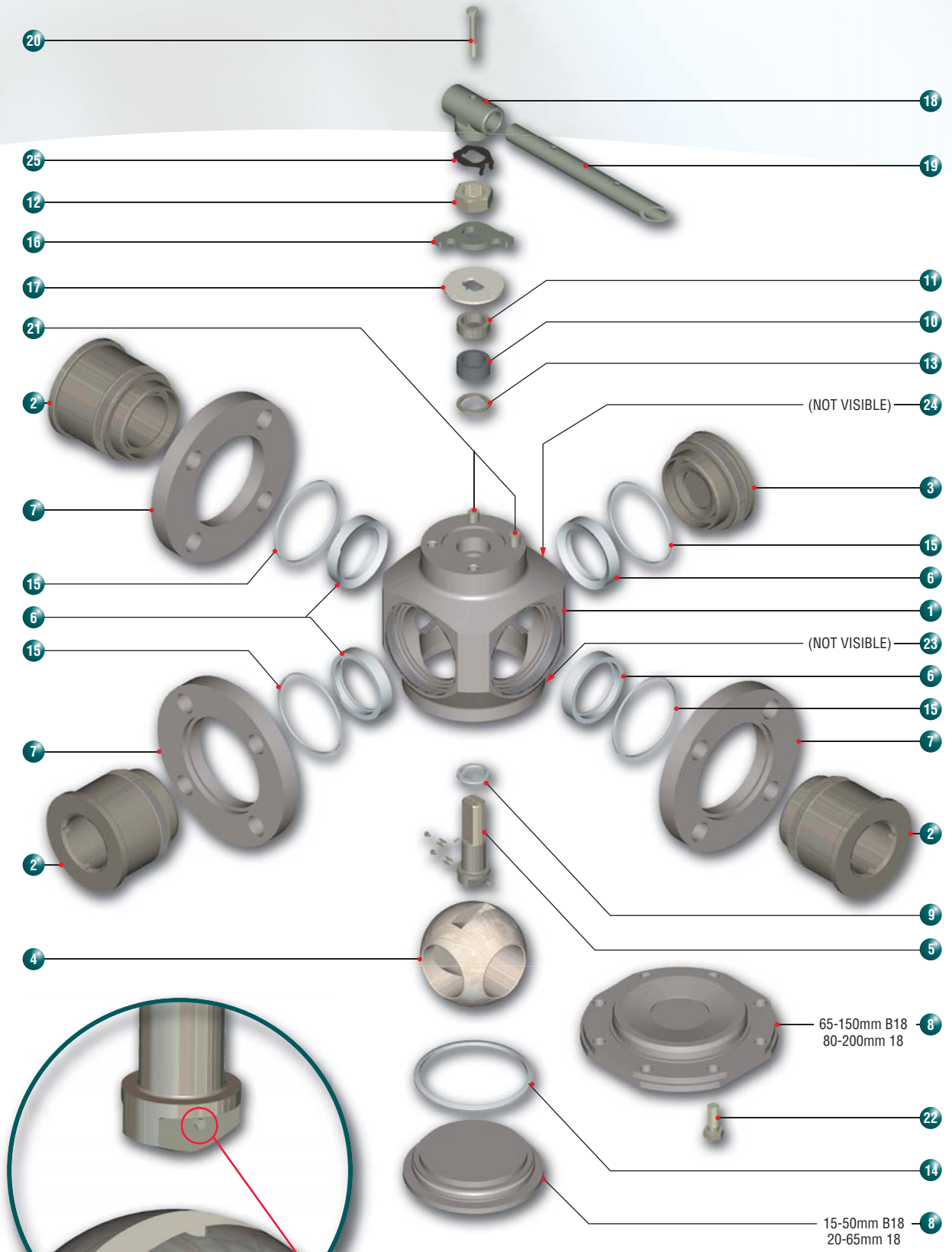

Detail showing stem location pin for correct orientation of ball to stem

15-25mm B18, 20-32mm 18 Wrench / Stem Assembly

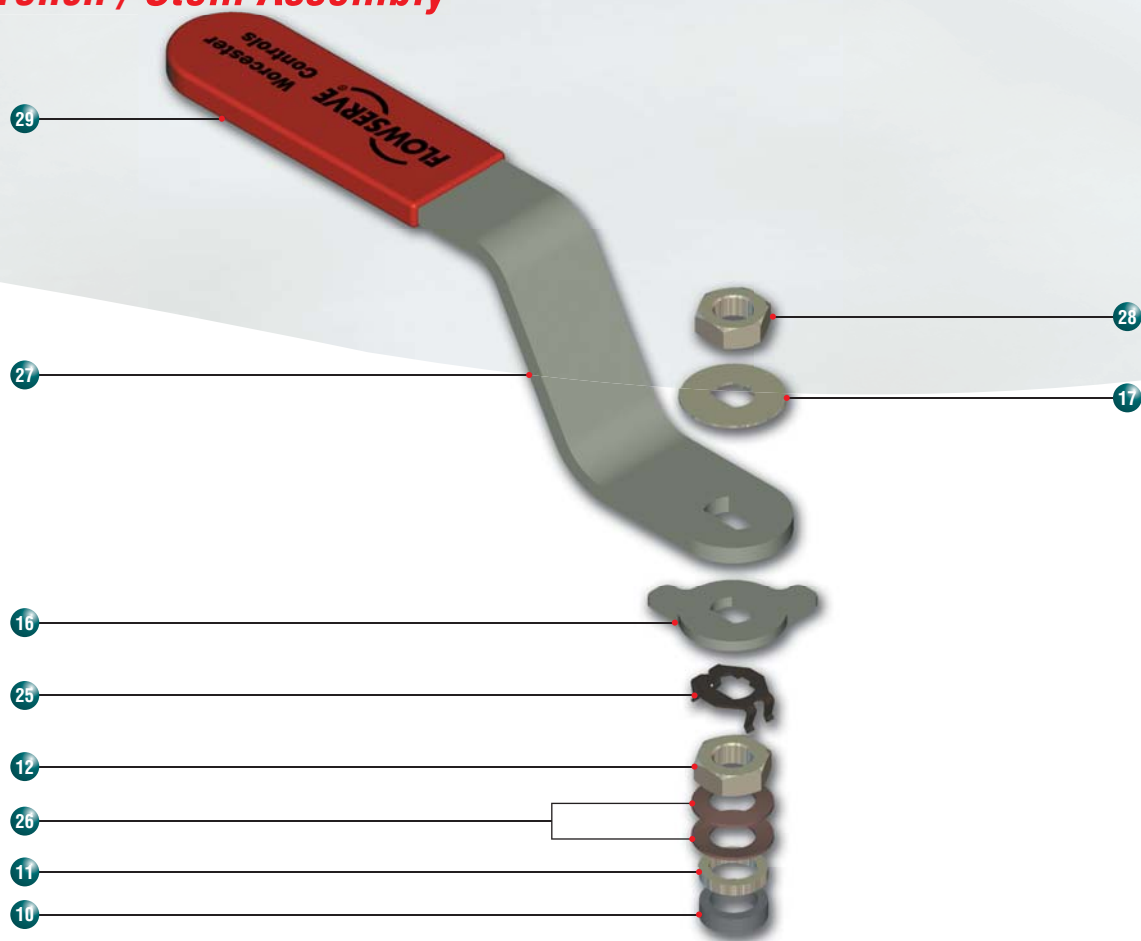

Part / Materials List

ITEM	DESCRIPTION	MATERIAL	ITEM	DESCRIPTION	MATERIAL
1	Body	Stainless Steel 316 Carbon steel BS 970 070M20	15*	Flange Port Insert Seal	Flexible Graphite
2	Flange Port Insert	Stainless Steel 316 Carbon steel BS 970 070M20	16	Stop Plate	Stainless Steel 304 Carbon Steel BS 1449 CS4
3	Blank Port Insert	Stainless Steel 316 Carbon steel BS 970 070M20	17	Flow Indicator	Stainless Steel 321
4	Ball	Stainless Steel 316	18	Wrench Head	Malleable Iron Rustproofed
5	Stem	Stainless Steel 316	19	Wrench Tube	Carbon Steel Rustproofed
6*	Seat Ring	PTFE Virgin (T) Fluorofill (p)	20	Wrench Bolt	Stainless Steel BS EN ISO 3506 A4-80
7	Slip Flange	Stainless Steel 316 Carbon steel EN 10083-1	21	Stop Pin	Stainless Steel 316 Carbon Steel BS 970 220M07
8	Ball Assembly Plate	Stainless Steel 316 Carbon steel EN 10083-1	22	Hex Head Screw (65-150mm B18 80-200mm 18 only)	Stainless Steel BS EN ISO 3506 A4-80 Carbon Steel BS 3692 GR 8.8
9*	Stem Thrust Seal	PTFE 25% Glass Filled	23	Identification Plate	Stainless Steel 304
10*	Gland Packing (See Notes)	Flexible Graphite	24	Body Plate	Stainless Steel 304
11	Gland	Stainless Steel 316	25	Gland Nut Locking Clip	Spring Steel
12*	Gland Nut	Stainless Steel 316 Carbon steel EN 10083-1	26*	Disc Springs (Only 15-25 B18 20-32mm 18)	Stainless Steel
13	Stem Locating Ring (65-15mm B18 80-200mm 18 only)	Stainless Steel 316	27	Wrench (Only 15-25mm B18 20-32mm 18)	Carbon Steel Rustproofed
14*	Ball Assembly Plate Seal	Flexible Graphite	28	Wrench Nut (Only 15-25mm B18 20-32mm 18)	Stainless Steel 316
* Items marked thus denote component supplied in repair kit Notes: For 15-50mm (B18), 20-65mm (18) valves, one gland packing is used. For 65-150mm (B18), 80-200 (18) valves, two are used.			29	Wrench Sleeve (Only 15-25mm B18 20-32mm 18)	Vinyl Plastinol











18/B18 Series Multi-Way Side Entry (Plan View)





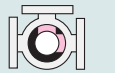



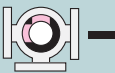

90° Options				
'L' Port	'T' Port			
LA1	TA1	TA2	TA3	TA4









180° Options				
'L' Port	'T' Port			
LB1	TB1	TB2	TB3	TB4

90° Options		180° Options		90° Options
'T' Port	'X' Port	'T' Port	'T' Port	'L' Port 90°
TA5	XA1	LB2	TB5	LA2

19/B19 Series Multi-Way Bottom Entry (Plan View)

90° Options			
'L' Port		'T' Port	
LA1	LA2	TA1	TA2
			
			
			

180° Options			
'T' Port			
TB1	TB2	TB3	TB4
			
			
			

180° Options		
'L' Port		
LB1	LB2	LB3
		
		
		

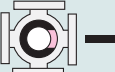
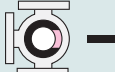
90° Options	
'L' Port	
LD1	LD2
	
Each port in Sequence	Each port in Sequence

Series 18/B18 (Side Entry)

15-25mm B18 - Full Bore
20-32mm 18 - Reduced Bore

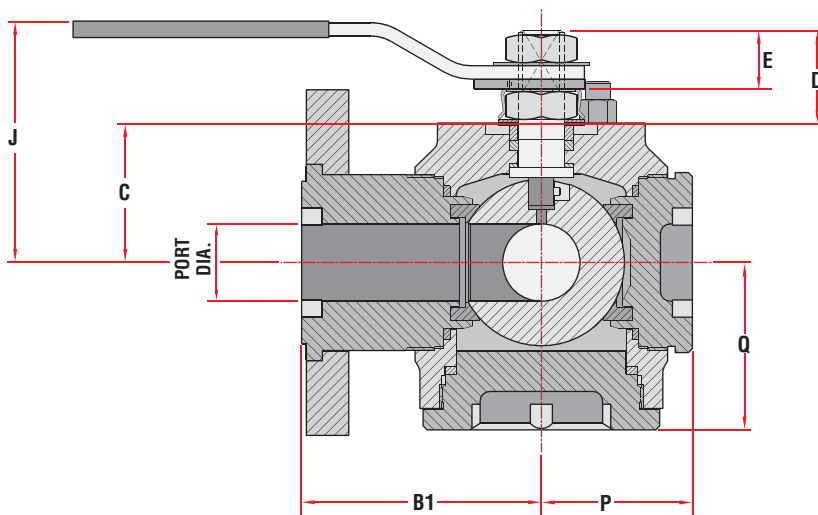
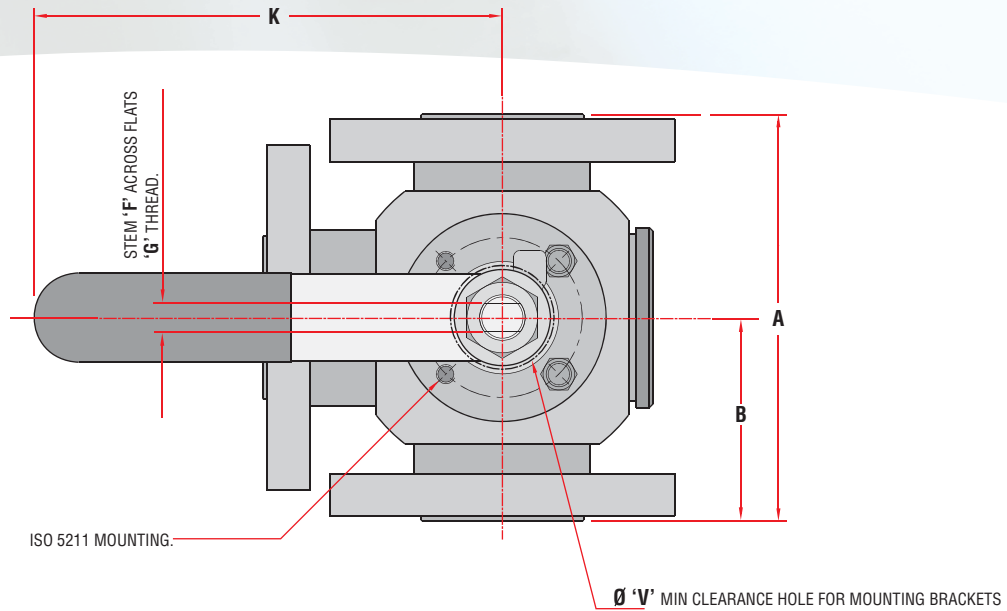

Valve Dimensions (Full Bore)

VALVE SIZE B18	VALVE SIZE 18	PORT SIZE Ø MIN	FACE TO FACE OPTIONS										C	D	E	STEM		J	K	P	Q	V Ø	ISO 5211 Mounting	Approx. Weight Kg
			A			B			B1							F A/F	G THREAD							
			CL150/PN16	CL300	PN16 & PN40	CL150/PN16	CL300	PN16 & PN40	CL150/PN16	CL300	PN16 & PN40	CL300												
DN15	DN20	12.5	108.0	140.0	130.0	54.0	70.0	65.0	70.0	70.0	65.0	30.1 29.3	24.04 22.36	15.19 14.69	7.54 7.47	7/16"-20 UNF	111.8	166.6	35.8	38.5	22.5	F04	3.5	
DN20	DN25	17.0	117.0	152.0	150.0	58.5	76.0	75.0	76.0	76.0	75.0	34.6 33.8	24.04 22.36	15.19 14.69	7.54 7.47	7/16"-20 UNF	116.3	166.6	41.8	40.2	22.5	F04	5.1	
DN25	DN32	24.0	127.0	165.0	160.0	63.5	82.5	80.0	75.0	82.5	80.0	44.0 43.2	29.78 28.10	18.39 17.89	8.71 8.64	9/16"-16 UNF	120.8	192.0	47.3	51.8	29.5	F05	7.5	

* Indicates tapped holes in all flanges

Series 18/B18 (Side Entry)
40-50mm B18 - Full Bore
50-65mm 18 - Reduced Bore

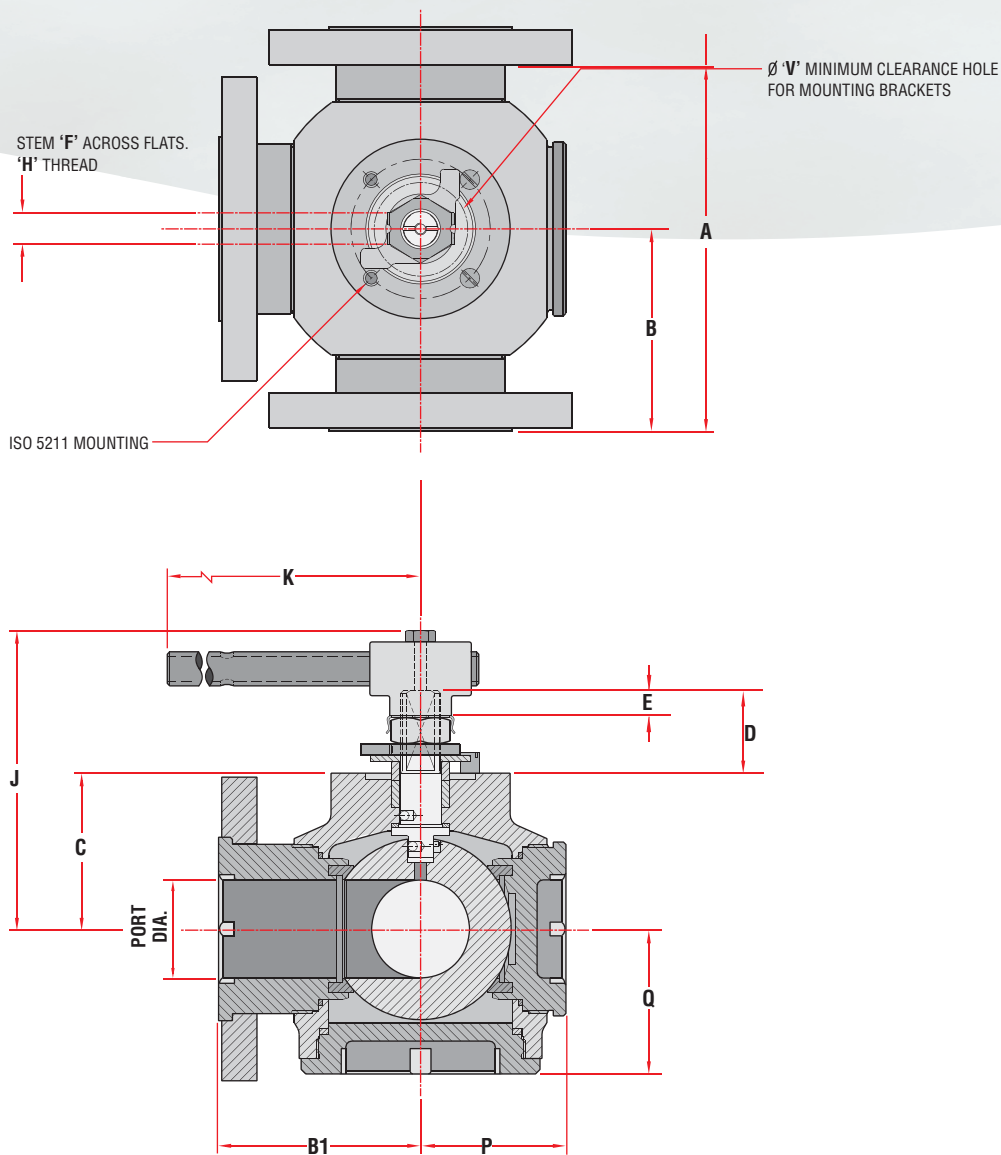

Valve Dimensions (Full Bore)

VALVE SIZE B18	VALVE SIZE 18	PORT Ø MIN	FACE TO FACE OPTIONS										C	D	E	STEM		J	K	P	Q	V Ø	ISO 5211 Mounting	Approx. Weight Kg
			A			B			B1							F	H							
			CL150/ PN16	CL300	PN16 & PN40	CL150/ PN16	CL300	PN16 & PN40	CL150/ PN16	CL300	PN16 & PN40	CL300				A/F	THREAD							
DN40	DN50	37.0	BS2080 TABLE 19 COL. 8	BS2080 TABLE 19 COL. 12	DIN3202 F1	BS2080 TABLE 19 COL. 8	BS2080 TABLE 19 COL. 12	DIN3202 F1	BS2080 TABLE 19 COL. 8	BS2080 TABLE 19 COL. 12	DIN3202 F1	69.6 68.8	42.8 40.4	10.6	14.00 13.85	M20 X 1.5p	136.5	225.0	58.3	64.3	53.5	F07	12.0	
DN50	DN65	49.0	203.0	216.0	230.0	101.5	108.0	115.0	101.5	108.0	115.0	78.6 77.8	42.8 40.4	10.6	14.00 13.85	M20 X 15.p	145.5	225.0	73.1	72.8	53.5	F07	19.5	

Series 18/B18 (Side Entry)

65-150mm B18 - Full Bore

80-200mm 18 - Reduced Bore

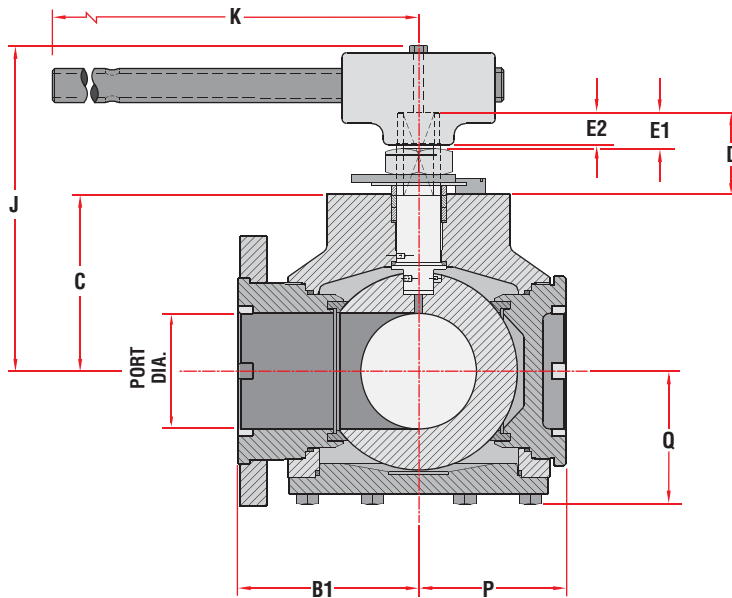
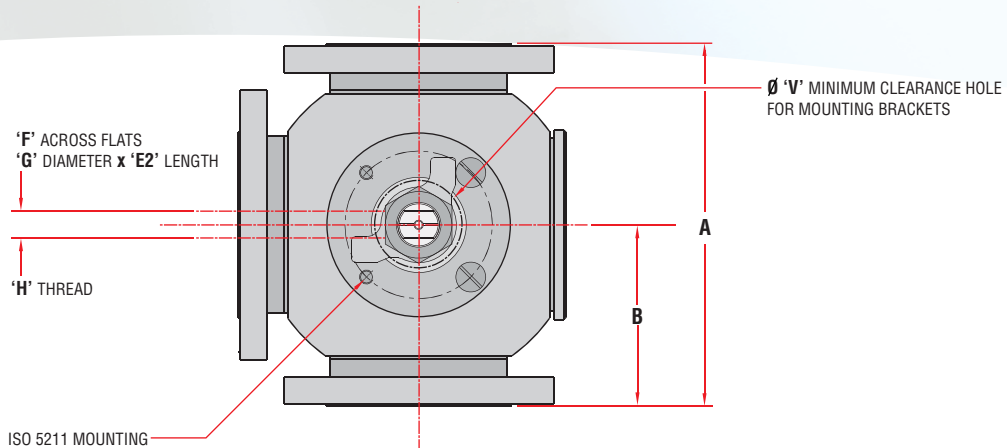

Valve Dimensions (Full Bore)

VALVE SIZE B18	VALVE SIZE 18	PORT Ø MIN	FACE TO FACE OPTIONS																							
			A			B			B1																	
			CL150/ PN16	CL300	PN16 & PN40	CL150/ PN16	CL300	PN16 & PN40	CL150	CL300	PN16 & PN40															
BS EN 558-2 TABLE 6 SERIES 12	BS EN 558-2 TABLE 6 SERIES 4	BS EN 558-1 TABLE 6 SERIES 1	BS EN 558-2 TABLE 6 SERIES 12	BS EN 558-2 TABLE 6 SERIES 4	BS EN 558-1 TABLE 6 SERIES 1	BS EN 558-2 TABLE 6 SERIES 12	BS EN 558-2 TABLE 6 SERIES 4	BS EN 558-1 TABLE 6 SERIES 1	BS EN 558-2 TABLE 6 SERIES 12	BS EN 558-2 TABLE 6 SERIES 4	BS EN 558-1 TABLE 6 SERIES 1	C	D	E1	E2	F A/F	STEM Ø THREAD		J	K	P	Q	V Ø	ISO 5211 Mounting	Approx. Weight Kg	
DN65	DN80	64.0	222.0	241.0	290.0	111.0	120.5	145.0	120.5	145.0	130.0	145.0	103.3 102.5	47.80 45.35	15.77	16.7 15.9	15.87 15.77	23.00 22.75	1"-14 UNS	189.0	350.0	89.8	88.4	68.0	F10	37.0
DN80	DN100	75.0	241.0	283.0	310.0	120.5	141.5	155.0	120.5	141.5	155.0	155.0	113.3 112.5	47.80 45.35	15.77	16.7 15.9	15.87 15.77	23.00 22.75	1"-14 UNS	199.0	350.0	105.2	97.8	68.0	F10	47.0
DN100	DN150	98.0	305.0	305.0	350.0	152.5	152.5	175.0	152.5	175.0	175.0	175.0	150.4 149.6	70.15 67.70	28.45	26.4 25.4	23.8 23.7	35.30 35.05	1½"-12 UNF	280.4	850.0	125.3	112.3	82.0	F12	83.0
DN150	DN200	148.0	394.0	403.0	480.0	197.0	201.5	240.0	197.0	201.5	240.0	240.0	186.8 186.0	70.70 68.25	28.45	26.4 25.4	23.8 23.7	35.30 35.05	1½"-12 UNF	317.4	850.0	163.0	175.7	82.0	F12	168.0

Pressure Temperature Ratings

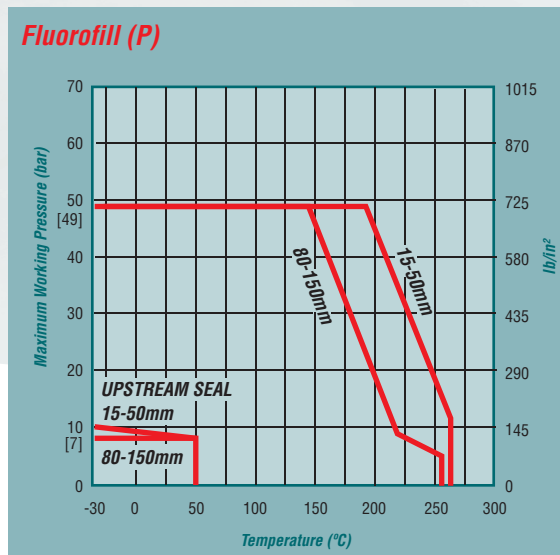
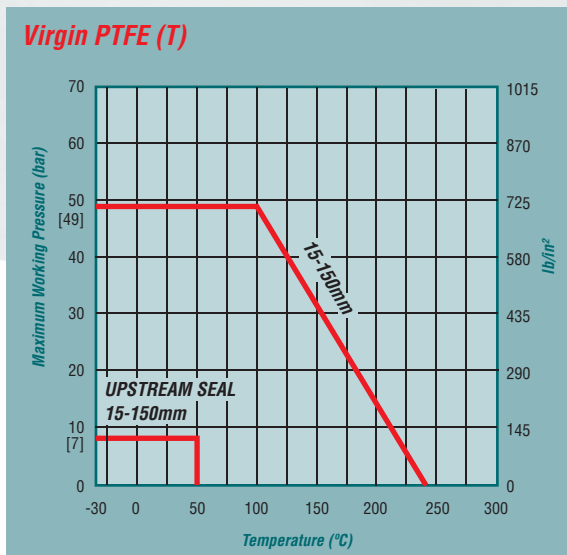

Notes

- Both 90° and 180° can be actuated pneumatically or electrically.
- Alternative seat/seal materials are available.
- Installation, Operating and Maintenance Instructions are supplied with products and are also available on request.
- Some flanges have tapped bolt holes.
- If required, dissimilar flange materials to body can be supplied.
- Non preferred face to face dimensions can be accommodated.
- B18 Full bore series sizes quoted. For 18 series reduced bore, use one size up (i.e. 15mm B18 = 20mm 18)
- The bottom port of ½" to 2" B19 Series is a fabricated (welded) construction.

Flow Coefficients

Valves Size (Full Bore)		Straight Through Flow		90° Branch		Double 'X'	
mm	in	Cv	Kv	Cv	Kv	Cv	Kv
15	¼	10	9	6	5	4	3
20	½	24	21	14	12	8	7
25	1	44	38	25	22	16	14
40	1½	104	90	60	52	38	33
50	2	194	169	112	97	71	62
65	2½	311	269	180	156	124	107
80	3	449	390	259	196	160	139
100	4	820	713	474	412	280	243
150	6	1965	1708	1135	986	658	571

CV - Flow in US GPM Pressure - psi
 Kv - Flow in M³/hr Pressure - bar

Standards of Compliance

Testing	Valves are tested to the requirements of BS 6755 Part 1 in the downstream sealing mode and are firesafe to external leakage requirement of BS 6755 Part 2
Face to Face Dimensions (of 2 opposing flanges on a 3-way valve) (See Note 6)	BS EN 558-2 Table 6 ISO 5752 - Table 6 ASME B16.10 - Tables 1 and 2 API 6D - Table 4.3 DIN 3202 - Table 5.1
Flange dimensions (See Note 4)	BS EN 1759 Class 150/Class 300 BS EN 1092 PN 10/16/25/40

NOTE:

Stainless steel valves are CE Marked in accordance with the Pressure Equipment Directive 97/23/EC, conformity assessment Module H and are classified in Category III (not end of line duty). Carbon steel valves are classified as SEP (Sound Engineering Practice) and, in accordance with the Pressure Equipment Directive, are not CE Marked. These valves may be used within the limitations defined in Annex II of the Directive.

The Series 18/19



Non-Flanged Ends*

In addition to slip flanges, the Series 18/19 can be supplied with a variety of end connections including socket weld and butt weld to suit customer requirements, screwed ends threaded to BSP and NPT, as well as tri-clamp ends and others.

*Please note, these are not available in all sizes, for further information on connection configuration, consult Flowserve Worcester Controls.



High Integrity Option

This configuration incorporates Worcester's unique dual sealing 'Enviro-Safe' stem assembly specifically designed for use on toxic, polluting and expensive media.



Size Range

Shown here is the 150mm (6") full bore multi-way valve compared with the 20mm (¾") size.



Special Materials

The flexibility of this product is further enhanced by the variety of materials of construction which, amongst others, includes Nickel Aluminium Bronze (shown opposite), Hastelloy, Titanium, Duplex etc.



Special Adaptions

Special variants of the product, such as a bleed valve to facilitate draining, can be fitted to the valve. Other adaptations can be readily accommodated.



Actuated Multi-Way

To complement the Series 18/19 range, Norbro offer pneumatic and electric actuators which can provide both 90° and 180° operation as standard with other options available.

FCD WCEBR0002-02 Printed in Germany.

Due to continuous development of our product range, we reserve the right to alter the dimensions and information contained in this leaflet as required. Information given in this leaflet is made in good faith and based upon specific testing but does not, however, constitute a guarantee.



Flowserve Flow Control

A Division of Flowserve GB Ltd
Burrell Road, Haywards Heath
West Sussex RH16 1TL
United Kingdom

Telephone: +44 (0)1444 314400

Telefax: +44 (0)1444 314401

Email: wvukinfo@flowserve.com